

STATE OF NORTH CAROLINA
DEPARTMENT OF TRANSPORTATION

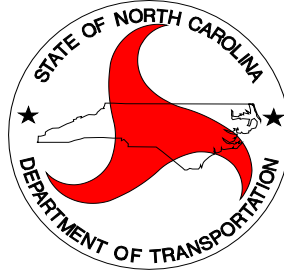

REQUEST FOR PROPOSAL

DATE AND TIME OF BID OPENING: DECEMBER 2, 2024 AT 2:00 P.M.

BID PROPOSAL NO.: 54-SH-05-PR12757

WBS ELEMENT NOS.: VARIOUS

COUNTY: VANCE – DIVISION 5

**TYPE OF WORK: STATE ROUTE SHOULDER AND MEDIAN MOWING
INCLUDING VEGETATION TRIMMING AND
LITTER/DEBRIS REMOVAL**

DATE OF AVAILABILITY: MARCH 1, 2025

COMPLETION DATE: FEBRUARY 28, 2026

PRE-QUALIFICATION MANDATORY

Table of Contents

PROPOSAL4

PROJECT SPECIAL PROVISIONS - GENERAL.....5

DEFINITIONS OF TERMS5

STANDARD SPECIFICATIONS5

MANDATORY PRE-BID5

BID QUESTIONS5

TERM OF THE CONTRACT6

MULTI-YEAR MAINTENANCE CONTRACTS7

PERFORMANCE GUARANTEE7

DESCRIPTION OF THE WORK7

TYPICAL SECTION7

SYSTEMS TO BE MOWN, TRIMMED, AND LITTER REMOVED8

ROUTINE/CLEANUP MOWING8

MOWING HEIGHT8

REQUIRED MOWING EQUIPMENT8

MOWING EQUIPMENT RESTRICTIONS9

LIQUIDATED DAMAGES9

INTERMEDIATE COMPLETION TIME NUMBER 110

LIQUIDATED DAMAGES10

VEGETATION REMOVAL AT STATIONARY OBJECTS (TRIMMING)10

REQUIRED PERSONNEL AND EQUIPMENT11

INTERMEDIATE COMPLETION TIME AND LIQUIDATED DAMAGES11

LITTER/DEBRIS REMOVAL11

INTERMEDIATE CONTRACT TIME AND LIQUIDATED DAMAGES12

DAY AND TIME RESTRICTIONS FOR MOWING, TRIMMING, AND LITTER/DEBRIS REMOVAL12

HOLIDAY AND HOLIDAY WEEKEND WORK RESTRICTIONS12

FUEL PRICE ADJUSTMENT PAPER BID:15

PROJECT SPECIAL PROVISIONS.....16

GENERAL TERMS AND CONDITIONS16

PAYMENT AND RETAINAGE16

CONTRACTOR17

GENERAL INFORMATION18

PLANT AND PEST QUARANTINES19

GENERAL SPECIFICATIONS20

MOWING20

VEGETATION REMOVAL AT STATIONARY OBJECTS (TRIMMING)21

LITTER/DEBRIS REMOVAL.....21

INSPECTION, ACCEPTANCE, MEASUREMENT, AND PAYMENT23

EQUIPMENT24

TRAFFIC CONTROL AND WORK ZONE SAFETY26

MINORITY BUSINESS ENTERPRISE AND WOMEN BUSINESS ENTERPRISE (DIVISIONS):30

STANDARD SPECIAL PROVISIONS.....42

AUTHORITY OF THE ENGINEER42

MINIMUM WAGES42

RIGHT OF THE CONTRACTOR TO FILE CLAIM43

DEFAULT OF CONTRACT43

SUBLETTING OF CONTRACT.....43

SAFETY AND ACCIDENT PROTECTION43

UTILITY CONFLICTS.....43

POSTED WEIGHT LIMITS44

NO MAJOR CONTRACT ITEMS.....44

NO SPECIALTY ITEMS.....44

SUBSURFACE INFORMATION.....44

RESTRICTIONS ON ITS EQUIPMENT AND SERVICES44

***USE OF UNMANNED AIRCRAFT SYSTEM (UAS)*45**

OUTSOURCING OUTSIDE OF THE USA45

APPENDIX52

TYPICAL SECTIONS.....53

MULTI-LANE OPERATION DIAGRAMS.....62

TYPICAL SECTIONS FOR TRIMMING AND LITTER PICKUP OPERATION65

LITTER PICKUP OPERATION DIAGRAMS66

THREATENED AND ENDANGERED PLANT SPECIES SIGN74

PREPARATION AND SUBMISSION OF TRADITIONAL PAPER BIDS75

OPENING OF BIDS76

BID SUBMITTAL PACKAGE1

CONTRACT BID FORM2

CONTRACTOR INFORMATION.....3

FEDERAL EMPLOYER IDENTIFICATION NUMBER4

REFERENCES.....5

LIST OF MBE & WBE SUBCONTRACTORS6

LIST OF EQUIPMENT7

DEBARMENT CERTIFICATION.....15

CHECKLIST FOR BIDDER.....17

PROPOSAL
FOR THE CONSTRUCTION OF
BID NO. 54-SH-05-PR12757 IN VANCE COUNTY, NORTH CAROLINA
NOVEMBER 4, 2024
DEPARTMENT OF TRANSPORTATION,
RALEIGH, NORTH CAROLINA

The Bidder has carefully examined the location of the proposed work to be known as **BID NO. 54-SH-05-PR12757**; has carefully examined the plans and specifications, which are acknowledged to be part of the proposal, the special provisions, the proposal, the form of contract; and thoroughly understands the stipulations, requirements and provisions. The undersigned bidder agrees to bound upon his execution of the bid and subsequent award to him by the Department of Transportation in accordance with this proposal. The undersigned Bidder further agrees to provide all necessary machinery, tools, labor, and other means of construction; and to do all the work and to furnish all materials, except as otherwise noted, necessary to perform and complete the said contract in accordance with *the 2024 Standard Specifications for Roads and Structures* by the dates(s) specified in the Project Special Provisions and in accordance with the requirements of the Engineer, and at the unit or lump sum prices, as the case may be, for the various items given on the sheets contained herein.

The Bidder shall provide and furnish all the materials, machinery, implements, appliances and tools, and perform the work and required labor to construct and complete State Highway **BID NO. 54-SH-05-PR12757** for the unit or lump sum prices, as the case may be, bid by the Bidder in his bid and according to the proposal, plans, and specifications prepared by said Department, which proposal, plans, and specifications show the details covering this project, and hereby become a part of this contract.

The published volume entitled *North Carolina Department of Transportation, Raleigh, Standard Specifications for Roads and Structures, January 2024* with all amendments and supplements thereto, is by reference incorporated into and made a part of this contract; that, except as herein modified, all the construction and work included in this contract is to be done in accordance with the specifications contained in said volume, and amendments and supplements thereto, under the direction of the Engineer.

If the proposal is accepted and the award is made, the contract is valid only when signed either by the Contract Officer or such other person as may be designated by the Secretary to sign for the Department of Transportation. The conditions and provisions herein cannot be changed except over the signature of the said Contract Officer or Division Engineer.

The quantities shown in the itemized proposal for the project are considered to be approximate only and are given as the basis for comparison of bids. The Department of Transportation may increase or decrease the quantity of any item or portion of the work as may be deemed necessary or expedient.

An increase or decrease in the quantity of an item will not be regarded as sufficient ground for an increase or decrease in the unit prices, nor in the time allowed for the completion of the work, except as provided for the contract.

PROJECT SPECIAL PROVISIONS - GENERAL

DEFINITIONS OF TERMS

GENERAL

Whenever the terms defined in this section are used in the contract, in any of the contract documents, or in the plans, the intended meaning of such terms shall be as defined in this section.

ABBREVIATIONS

MUTCD _____	<i>Manual on Uniform Traffic Control Devices</i>
N.C.G.S. _____	North Carolina General Statute
NCDOT _____	North Carolina Department of Transportation
POC _____	Purchase Order Contract
RFP _____	Request for Proposal
RSD _____	<i>2024 Roadway Standard Drawings</i>
SSRS _____	<i>2024 Standard Specifications for Roads and Structures</i>
TCD _____	Traffic Control Devices
TMA _____	Truck Mounted Attenuator
U.S.C _____	United States Code

STANDARD SPECIFICATIONS

Unless otherwise stated, all work and materials shall be in accordance with the provisions of this contract, the SSRS, the RSD, and the MUTCD.

The Contractor shall keep fully informed of all Federal, State, and local laws, ordinances, and regulations; and shall comply with the provisions of Section 107 of the SSRS.

These manuals may be found at the following websites: <http://mutcd.fhwa.dot.gov/> and <https://connect.ncdot.gov/resources/Specifications/Pages/2024-Specifications-and-Special-Provisions.aspx>.

MANDATORY PRE-BID

Please be advised that any references in the RFP to pre-bid language will not apply as a pre-bid will not be held for this contract. If bidders have questions, they will be addressed in an addendum.

BID QUESTIONS

Purpose: Upon review of the bid documents, bidders may have questions to clarify or interpret the bid in order to submit the best bid possible. To accommodate the Bid Questions process, bidders shall submit by email any such questions **no later than November 12, 2024 at 5:00 PM**. A response to bidder questions will be in the form of an addendum.

Instructions: Written questions shall be emailed to **Steve Hussey** sthussey@ncdot.gov by the date and time specified above. Bidders will enter “**54-SH-05-PR12757 – Questions**” as the subject for the email. Questions received prior to the submission deadline date, the State’s response, and any additional terms deemed necessary by the State will be documented and included in an addendum to be posted on Connect NCDOT:

<https://connect.ncdot.gov/letting/Pages/Roadside-Environmental.aspx> and on the electronic Vendor Portal (eVP),

<https://evp.nc.gov>. No information, instruction or advice provided orally or informally by any State personnel, whether made in response to a question or otherwise in connection with this RFP, shall be considered authoritative or binding. Bidders shall be entitled to rely only on written material contained in an Addendum to this RFP.

The Contractor must sign the addendum signature page(s) where indicated and the entire addendum should be returned with the bid package. Please return the entire addendum, but failure to return the executed signature page(s) of the addendum may result in disqualification of bid.

CONTRACTOR PREQUALIFICATION

Any firm that wishes to perform work on this POC as either the prime contractor or as a subcontractor must be pre-qualified for the type work they wish to perform (including but not necessarily limited to NCDOT Work Code “016607 Mowing”). The Contractor performing the Work Zone Traffic Control (either as the prime contractor or as a subcontractor) will be required to be prequalified for the NCDOT Work Code “001105 Work Zone Traffic Control Devices”.

Firms that wish to bid on these projects as the prime contractor must be pre-qualified as either a “Bidder” or “Purchase Order Contract (POC) Prime Contractor” prior to submitting the bid. Firms that wish to perform as a subcontractor to the prime contractor must be pre-qualified prior to beginning work on the project.

Prospective bidders shall obtain prequalification approval at least two (2) business days prior to any letting in which they intend to submit a bid. It is recommended that the prospective bidder file all required statements and documents with the State Prequalifications Engineer no less than four (4) weeks before a given letting. A bid shall not be opened unless all prequalification requirements have been met by the bidder and have been found acceptable by the Engineer.

Information regarding prequalification can be found at: <https://connect.ncdot.gov/business/Prequal/Pages/default.aspx>

Note: The Contractor performing Work Zone Traffic Control shall have a minimum of one (1) NCDOT Certified Work Zone Supervisor. In order to become a Certified Work Zone Supervisor see information found at: <https://connect.ncdot.gov/projects/WZTC/Pages/Training.aspx>. At no time during the contract is the Contractor to be without a NCDOT Certified Work Zone Supervisor.

INTERESTED PARTIES LIST NOT REQUIRED:

(6-21-22)(Rev. 2-20-24)

102

SP1 G02

Revise the *Standard Specifications* as follows:

The *Interested Parties List* sign up process is not applicable to this contract.

Page 1-13, Article 102-3 PROPOSALS AND INTERESTED PARTIES LIST, lines 12-15, delete the first paragraph.

Page 1-14, Article 102-8 PREPARATION AND SUBMISSION OF BIDS, lines 43-44, delete the first sentence of the first paragraph.

TERM OF THE CONTRACT

A contract awarded pursuant to this RFP shall have an effective date of March 1, 2025.

No work will be permitted and no purchase order will be issued until all required bonds (if applicable) and prerequisite conditions and certifications have been satisfied.

The completion date shall be February 28, 2026. At its discretion, NCDOT may offer extension of the contract for an additional term up to a maximum of five (5) total terms (original term and four (4) renewals). Extensions for additional term(s) are not guaranteed and are at the sole discretion of NCDOT.

The Engineer will notify the Contractor in writing by September 1 of each available term if the contract may be extended or not extended. The Engineer must receive a signed response from the Contractor within two calendar weeks of the date of the offer letter. Failure by the Contractor to reply may be received as a rejection of contract extension.

For each contract renewal, each unit bid will be adjusted by the Bureau of Labor Statistics' Consumer Price Index, using the unadjusted percent change from July (previous term) to July (current term) for the "Services" category of the "Urban Wage Earners and Clerical Workers" table. This data can be found at https://data.bls.gov/timeseries/CWUR0000SAS?output_view=pct_12mths. No changes in the terms, conditions, etc. of this contract will be made when an extension to the contract is implemented, notwithstanding necessary adjustments to cycles and mileage quantities as permitted by the terms of the contract.

MULTI-YEAR MAINTENANCE CONTRACTS

(4-20-21) (Rev. 4-19-22)

SP1 G76

This contract is a multi-year maintenance contract let pursuant to the provisions of N.C. General Statute §136-28.1(b). In accordance with N.C. General Statute §136-28.1(b), an award in a maintenance contract may be for an amount less but shall not exceed \$5,000,000 per year. No payments in excess of this amount will be disbursed, in accordance with the Statute.

PERFORMANCE GUARANTEE

Upon award of contract, the Contractor is required to choose one of the following Performance Guarantee Options by indicating his/her selection on the form provided with the award letter.

Option 1:

Performance and Payment Bonds: A Performance Bond in the amount of one hundred percent (100%) of the contract amount, conditioned upon the faithful performance of the contract in accordance with specifications and conditions of the contract. Such bond shall be solely for the protection of the North Carolina Department of Transportation and the State of North Carolina. The bond will remain in force for the duration of the contract, including extension(s).

In addition, a Payment Bond in the amount of one hundred percent (100%) of the contract amount, conditioned upon the prompt payment for all labor or materials for which the Contractor, or his subcontractors, are liable. Such bond shall be solely for the protection of persons or firms furnishing materials or performing labor for this contract for which the Contractor is liable. The bond will remain in force for the duration of the contract, including extension(s).

The Performance Bond and the Payment Bond shall be executed by one or more Surety Companies legally authorized to do business in the State of North Carolina and shall become effective upon awarding of the contract. The required bonds, 100% Performance Bond and 100% Payment Bond, shall be submitted to the Department's Purchasing Section within fourteen (14) days after notice of award. If not received, the Department reserves the right to cancel the award and consider other bids.

Option 2:

Retainage Fee: For the initial term and any extensions, the NCDOT shall retain six percent (6%) from the amount of each invoice as a performance guarantee. This amount will be refunded without interest pending the project site review by NCDOT at the end of each term. In the event of default, this amount may be used by NCDOT to obtain services from another source.

DESCRIPTION OF THE WORK

Work includes mowing/trimming of vegetation, and litter/debris removal along State Highway System routes within Vance County. The furnishing of all equipment, tools, materials, transportation, and labor shall be incidental to completion of the work.

TYPICAL SECTION

The terms "Swath" and "Ditch" are used to indicate standard mowing patterns for **routine** mowing cycles. Typically, Swath contracts require the mowing of an additional swath beyond the ditch line or shoulder point on each routine cycle;

whereas Ditch contracts only require mowing to the ditch line or shoulder point on each routine cycle. A Contract awarded pursuant to this RFP will use the Swath typical section for routine mowing cycles on all routes.

Cleanup mowing cycles shall include the area established for routine mowing and extend to the established tree/wood line or right-of-way, or as directed by the Engineer.

Please see the Appendix for mowing patterns.

SYSTEMS TO BE MOWN, TRIMMED, AND LITTER REMOVED

The Road Miles for each system along with the cycles are shown in the following table. The product of (Road Miles) x (Shoulders) x (Cycles) in Shoulder Miles will be reflected on the Contract Bid Form. The number of anticipated mowing, trimming, and litter/debris removal cycles is an estimate only, and may be increased or decreased by the Engineer due to budget or weather conditions. On routes where herbicidal treatments are used, the number of cycles may be less than the number of cycles required for the entire system.

System	Road Miles	Number of Cycles				
		Routine	Cleanup	Trimming	Litter	Long-arm
Interstate	15		5	3	3	
Primary Divided	16		5	3		
Primary Undivided	51		5			
Secondary Divided						
Secondary Paved	367		5			
Secondary Unpaved	18		5			

ROUTINE/CLEANUP MOWING

MOWING HEIGHT

Vegetation shall be cut to a height of six (6) inches. At the discretion of the Engineer mowing height may be adjusted as necessary but never less than four (4) inches.

REQUIRED MOWING EQUIPMENT

The Contractor shall provide at minimum (quantity) the following functional and operating equipment each cycle in the performance of mowing for this contract:

- 60" – 90" Mowers: -----6
- 10' – 15' Flex Wing Mowers:----- No minimum specified
- Long-arm Mowers:-----No minimum specified
- 60" to 72" Zero Turn type Mowers:-No minimum specified

This is the minimum amount of equipment specified for this project. Additional equipment may be required to successfully fulfill the contract. If no minimum equipment is specified above, the Contractor is expected to use judgment in gauging the amount of equipment needed to successfully fulfill the contract. Other equipment may be

necessary. Such equipment may include, but is not limited to: TMAs, sign trucks, narrow-deck or zero-turn mowers, trailers, mechanic trucks, handheld trimmers, fuel trucks, and supervisor vehicles.

Note: If the Contractor will not be self-performing the work, the Bidder shall present their lease/rental or subcontractor information with the bid response.

NOTE: THE AREA BETWEEN THE DOUBLE GUARDRAIL ON US-1 FROM US 1 BUSINESS TO I-85 WILL BE REQUIRED TO BE MOWED EVERY MOWING CYCLE AS PART OF ROUTINE MOWING.

If the Contractor demonstrates that the work can be performed on schedule with fewer tractors, the quantity may be reduced with prior approval of the Engineer.

A supervisor and service truck may be required for each county.

Areas that are not accessible by tractors shall be mown by whatever means necessary, including, but not limited to, long-arm, finishing, zero turn, and narrow deck mowers or trimmers. This includes, but is not limited to, areas behind or between guardrails, guiderails, back slopes, and/or ditches.

The Contractor will be required to have a minimum of one (1) 4WD tractor available at the direction of the Engineer.

The Contractor must have sufficient equipment to maintain all areas within the right-of-way or mowing pattern. Equipment limitation will not be an acceptable reason for leaving areas uncut unless approval is given by the Engineer.

MOWING EQUIPMENT RESTRICTIONS

Only rotary mowers shall be permitted on interstates. Batwing, half-batwing, and rotary mowers shall only be permitted on interstate and primary divided facilities. The Contractor is prohibited from using sickle mowers on any route. The Contractor is prohibited from using 15' mowers on secondary roads. The Contractor is prohibited from using mowers wider than the shoulder, unless sections are authorized by the Engineer. It is the Contractor's responsibility to remove in a timely manner any grass, brush, or debris deposited into the roadway, which includes travel lanes, shoulders, bulb-outs, ditches, and drainage structures, as a result of the Contractor's operations in order to eliminate any hazards. These limitations (if any) shall supersede any conflicting provision set forth in the Equipment section of the Project Special Provisions.

LIQUIDATED DAMAGES

The Contractor shall incur Liquidated Damages in the amount of **Two Hundred Fifty Dollars (\$250.00)** per tractor per work day for not fielding the minimum number of required operating mowers. The on job supervisor/service man will not meet this full time requirement.

The Contractor shall incur Liquidated Damages in the amount of **Five Hundred Dollars (\$500.00)** per tractor per incident for using prohibited mowers on routes as specified above.

The Contractor shall incur Liquidated Damages in the amount of **Five Hundred Dollars (\$500.00)** per incident for failing to remove in a timely manner any grass, brush, or debris deposited into the roadway, which includes travel lanes, shoulders, bulb-outs, ditches, and drainage structures, as a result of the Contractor's operations in order to eliminate any hazards.

The Contractor shall incur Liquidated Damages in the amount of **Two Dollars (\$2.00)** per linear foot shall be made where turf is damaged, scalped, or gouged along median guard/guide rail.

All damage to turf shall be repaired within fourteen (14) days of notification. If repairs are not made within stated time NCDOT will repair these areas and deduct the cost from the Contractor's next invoice.

The Contractor shall incur Liquidated Damages in the amount of **One Hundred Dollars (\$100.00)** per day, per mailbox shall be made when repairs, including supports, are not completed with twenty-four (24) hours of notification by the Department unless a delay in repairs has been approved by the Engineer. All repairs shall be equal to or better than the damaged mailbox and/or support.

The Contractor shall incur Liquidated Damages in the amount of **One Hundred Dollars (\$100.00)** per incident for failing to have required Contractor’s company name, identification number, and telephone number conspicuously and legibly displayed on each tractor, litter removal vehicle, and Service Vehicle.

If an inspector is unable to contact the mowing supervisor for any given county, at the telephone number provide by the Contractor, for a period exceeding twenty-four (24) hours, the Contractor shall incur Liquidated Damages in the amount of **One Hundred Dollars (\$100.00)** per occurrence.

Failure of the Contractor to ensure each supervisor has a cellular telephone and/or give advance notice of telephone number changes shall result in Liquidated Damages in the amount of **One Hundred Dollars (\$100.00)** per occurrence.

INTERMEDIATE COMPLETION TIME NUMBER 1

Intermediate Completion Times (ICTs) for cleanup mowing on interstate and primary routes, plus any additional mowing as directed by the Engineer in the respective cycle. Contractor shall begin work within five (5) working days of the Date of Availability. Refer to the following table for ICT dates. The Start Date for Cycle 1 in each year may be adjusted by the Engineer. If such a change is made, the Start Date and Finish Date of cycles 2-5 within that term will be adjusted forward or backward by the same number of days. If this contract is renewed, ICTs will apply to their respective renewal years.

Cycle	Date of Availability	Type of Cut	Date of Completion
1	April 21, 2025	Cleanup	May 1, 2025
2	May 27, 2025	Cleanup	June 6, 2025
3	June 30, 2025	Cleanup	July 10, 2025
4	August 11, 2025	Cleanup	August 21, 2025
5	October 15, 2025	Cleanup	November 15, 2025

LIQUIDATED DAMAGES

The Contractor shall incur Liquidated Damages in the amount of **Five Hundred Dollars (\$500.00)** for each calendar day for which mowing was done outside of the prescribed times.

VEGETATION REMOVAL AT STATIONARY OBJECTS (TRIMMING)

Note: Not all routes mown for this contract will receive vegetation trimming.

NOTE: THE AREA BETWEEN THE DOUBLE GUARDRAIL ON US-1 FROM US 1 BUSINESS TO I-85 WILL BE REQUIRED TO BE MOWED EVERY MOWING CYCLE AS PART OF ROUTINE MOWING.

ROUTE	MILEAGE	LINEAR FEET	SQUARE FEET
I-85	35.8	189,024	2,228

CYCLE

The intent is for the Contractor to perform three (3) cycles of trimming, however, the Engineer may increase or reduce the number of cycles. Trimming shall be performed as specified and as directed by the Engineer.

NOTIFICATION OF WORK

The Engineer will notify the Contractor when to begin a cycle, and on which routes the work is to be performed. The Contractor will have five (5) work days to commence operations after notification has been given by the Engineer. The Contractor shall give the Engineer 48 hours advance notice before commencing work within the five (5) work day notification period.

REQUIRED PERSONNEL AND EQUIPMENT

The Contractor shall provide a minimum of five (5) qualified operators with string trimmers.

INTERMEDIATE COMPLETION TIME AND LIQUIDATED DAMAGES

Cycle	Date of Availability	Completion Date
1	April 28, 2025	June 7, 2025
2	July 21, 2025	August 30, 2025
3	October 27, 2025	December 6, 2025

Trimming operations shall coincide with mowing operations and at no time shall be allowed to be more than seven (7) work days ahead or behind mowing operations or the Contractor shall be charged **Five Hundred Dollars (\$500.00)** per work day beginning the eighth work day after mowing and continuing until the time is within specifications.

The Contractor shall incur Liquidated Damages in the amount of **Two Hundred Fifty Dollars (\$250.00)** per work day for not beginning work within the five (5) day notification period beginning the sixth day after notification and continuing until work begins.

The Contractor shall incur Liquidated Damages in the amount of **Two Hundred Fifty Dollars (\$250.00)** for each calendar day for which acceptable completion of work is delayed beyond its intermediate Date of Completion.

The Contractor or his employees shall not pile dead grass clippings on drainage structures within the right-of-way. If this condition is found, it will be the Contractor’s responsibility to remove said vegetation and clean the interior of the drain that was covered. **If the Contractor fails to clean the area in question, then NCDOT will have the area cleaned and deduct the cost from the Contractor’s next invoice.**

LITTER/DEBRIS REMOVAL

Mowing operators shall avoid impacting collected bags of litter. The Contractor shall be responsible for gathering and removing any litter resulting from such an impact within four (4) hours of notification by the Engineer for no additional compensation in a manner determined by the Engineer. The Contractor shall incur Liquidated Damages in the amount of **Two Hundred Fifty Dollars (\$250.00)** for failure to complete the cleanup within four (4) hours of notification and as specified by the Engineer per hour or portion thereof that any resulting litter has not been removed by the Contractor.

At no time shall bags or collected litter/debris be allowed to remain on the right of way beyond the end of the work day. The Contractor shall incur Liquidated Damages in the amount of **Two Hundred Fifty Dollars (\$250.00)** per calendar day for not complying with the removal of litter/debris.

Note: Not all routes mown for this contract will receive litter pickup. Only interstate routes will receive litter pickup.

This operation will take place prior to each mowing cycle, or as directed by the Engineer.

As directed, the removal of litter shall occur prior to mowing operations for all primary road systems and to the extent practical on secondary roads as stated in G.S. 136-28.12 (a).

CYCLE

One (1) complete cleaning of the State Highway System mileage specified. Cleanup shall be performed as specified and as directed by the Engineer.

NOTIFICATION OF WORK

The Engineer will notify the Contractor when to begin a cycle, and on which routes the work is to be performed. It is anticipated that the cycles will be evenly distributed throughout the life of the contract. The Contractor will have ten (10) work days to commence operations after notification has been given by the Engineer. The Contractor shall give the Engineer 48 hours advance notice before commencing work within the ten (10) work day notification period. The

Engineer may notify the Contractor of additional work to be performed on any subject road project in this contract where subject road project is one mile in length or greater.

INTERMEDIATE CONTRACT TIME AND LIQUIDATED DAMAGES

The Date of Completion is the work day prior to the mowing Date of Availability during the mowing season. During other times the Date of Completion is prior to holiday travel times as directed by the Engineer.

The Contractor shall incur Liquidated Damages in the amount of **Five Hundred Dollars (\$500.00)** for each calendar day for which acceptable completion of work is delayed beyond its intermediate Date of Completion.

In addition, the Contractor shall incur Liquidated Damages in the amount of **Two Hundred Fifty Dollars (\$250.00)** per work-day until the work is completed for failure to complete litter removal before each mowing cycle.

DAY AND TIME RESTRICTIONS FOR MOWING, TRIMMING, AND LITTER/DEBRIS REMOVAL

The Contractor shall complete the required work of installing, maintaining and removing the traffic control devices where required. Unless approved by the Engineer, the Contractor shall not perform any work on this project and/or close or narrow a lane of traffic on this project during the following time restrictions:

- Monday–Friday from thirty (30) minutes before sunset to thirty (30) minutes after sunrise the following day.
- Saturday from thirty (30) minutes before sunset to thirty (30) minutes after sunrise the following Monday.

INTERMEDIATE CONTRACT TIME AND LIQUIDATED DAMAGES FOR MOWING, TRIMMING OF VEGETATION AND LITTER/DEBRIS REMOVAL

The Contractor shall not work within the roadway or associated right of way on any state maintained route, detain and /or alter the traffic flow on or during holiday weekends, special events, or any other time when traffic is unusually heavy, including the following schedules:

HOLIDAY AND HOLIDAY WEEKEND WORK RESTRICTIONS

1. For **unexpected occurrence** that creates unusually high traffic volumes, as directed by the Engineer.
2. For **New Year's Day**, between the hours of **4:00 p.m.** December 31st and **8:30 a.m.** January 2nd. If New Year's Day is on a Friday, Saturday, Sunday or Monday, then until **8:30 a.m.** the following Tuesday.
3. For **Martin Luther King, Jr. Day**, between the hours of **4:00 p.m.** Friday and **8:30 a.m.** Tuesday.
4. For **Easter**, between the hours of **4:00 p.m.** Thursday and **8:30 a.m.** Monday.
5. For **Memorial Day**, between the hours of **4:00 p.m.** Friday and **8:30 a.m.** Tuesday.
6. For **Independence Day**, between the hours of **4:00 p.m.** the day before Independence Day and **8:30 a.m.** the day after Independence Day.

If **Independence Day** is on a Friday, Saturday, Sunday or Monday, then between the hours of **4:00 p.m.** the Thursday before Independence Day and **8:30 a.m.** the Tuesday after Independence Day.

7. For **Labor Day**, between the hours of **4:00 p.m.** Friday and **8:30 a.m.** Tuesday.
8. For **Veteran's Day**, between the hours of **4:00 p.m.** the day before Veteran's Day observance and **8:30 a.m.** the day after Veteran's Day observance.
9. For **Thanksgiving Day**, between the hours of **4:00 p.m.** Tuesday and **8:30 a.m.** Monday.
10. For **Christmas**, between the hours of **4:00 p.m.** the Friday before the week of Christmas Day and **8:30 a.m.** the following Tuesday after the week of Christmas Day.

Holidays and holiday weekends shall include New Years, Easter, Memorial Day, Independence Day, Labor Day, Thanksgiving, and Christmas. The Contractor shall schedule his work so that work is not required during these periods, unless otherwise directed by the Engineer.

The time of availability for this intermediate contract work shall be the time the Contractor begins to install all traffic control devices where required or begins mowing operations according to the time restrictions listed herein.

The completion time for this intermediate contract work shall be the time the Contractor removes all traffic control devices where required or stops mowing operations according to the time restrictions listed herein.

Liquidated damages for this contract are **Two Hundred Fifty Dollars (\$250.00)** per hour or portion thereof that the Contractor operates outside of the work hours as stated above.

REMOBILIZATION FOR MOWING

DESCRIPTION

During a mowing cycle the Department may require the Contractor to remobilize all or a portion of their equipment to mow areas that are more than ten (10) miles, measured by the most direct route, from the location of the then current mowing operations. The Contractor shall be paid once for each remobilization event at the contract unit price for remobilization and will be paid for the shoulder miles mown at the contract line item unit price for mowing. Remobilization requests and instructions from the Department may be verbal, but shall be followed by written communication in the form of an email. Contractor will not be compensated for remobilization to address issues of unsatisfactory performance.

INTERMEDIATE COMPLETION TIME REMOBILIZATION

The date and time stamp on the Email communication requesting the Contractor to remobilize and begin mowing operations will serve as the date and time of availability. The intermediate completion time shall be seventy-two (72) hours from the date and time of availability.

The Contractor shall incur liquidated damages in the amount of **Fifty Dollars (\$50.00)** for each hour or portion thereof for which acceptable completion of remobilization and the commencement of mowing operations is delayed beyond the intermediate completion time.

PROSECUTION AND PROGRESS

The Contractor shall pursue the work diligently with workmen in sufficient numbers, abilities, and supervision, and with the equipment, materials, and methods of construction as may be required to complete the work described in the contract, or as may be amended, by the completion date and in accordance with Section 108 of the Standard Specifications.

The Contractor's vehicles and equipment shall not be parked within the State Highway System right of way overnight or at other times when work has been suspended unless approved by the Engineer, and in no case within 30 feet of the edge of pavement. The Engineer may designate specific locations for parking equipment.

The Contractor shall adhere to all applicable regulations and follow accepted safety procedures when working in the vicinity of utilities in order to insure the safety of construction personnel and the public.

In the event that the Contractor's operations are suspended in violation of the above provisions, the Contractor shall incur Liquidated Damages in the amount of the sum of **Five Hundred Dollars (\$500.00)** for each and every calendar day that such suspension takes place. The said amount is hereby agreed upon as liquidated damages due to extra engineering and maintenance costs and due to increased public hazard resulting from a suspension of the work. Liquidated damages chargeable due to suspension of the work will be additional to any liquidated damages that may become chargeable due to failure to complete the work on time.

SAFETY PRECAUTIONS

Failure to comply with any of the requirements for safety and traffic control of this contract shall result in suspension of work as provided in SSRS 108-7. All signs shall be clean, legible, and in good condition as determined by the Engineer.

TRAFFIC CONTROL

In addition, the Contractor shall incur immediate Liquidated Damages in the amount of **Five Hundred Dollars (\$500.00)** for each occurrence for failure to provide work zone signing as specified. The Contractor shall incur Liquidated Damages in the amount of **Two Hundred Fifty Dollars (\$250.00)** for each occurrence for failure to remove work zone signing at the end of the day.

LIGHTING AND SIGNAGE

In addition, the Contractor shall incur immediate Liquidated Damages in the amount of **Five Hundred Dollars (\$500.00)** for each occurrence for failure to provide operational lighting and signing on all equipment as specified.

SAFETY VESTS

In addition, the Contractor shall incur Liquidated Damages in the amount of **One Hundred Dollars (\$100.00)** per employee for each occurrence for failure to wear a safety vest as specified, which includes prohibiting the safety vests being blocked from view by backpacks, etc.

PROJECT SPECIAL PROVISIONS

Please see additional specifications for each operation pertaining to this proposal under Project Special Provisions “General Specifications”, “Inspection, Acceptance, Measurement, and Payment”, “Equipment”, and “Traffic Control and Work Zone Safety”.

EQUIPMENT IDLING GUIDELINES

(1-19-21)

107

SP1 G096

Exercise reduced fuel consumption and reduced equipment emissions during the construction of all work associated with this contract. Employees engaged in the construction of this project should turn off vehicles when stopped for more than thirty (30) minutes and off-highway equipment should idle no longer than fifteen (15) consecutive minutes.

These guidelines for turning off vehicles and equipment when idling do not apply to:

1. Idling when queuing.
2. Idling to verify the vehicle is in safe operating condition.
3. Idling for testing, servicing, repairing or diagnostic purposes.
4. Idling necessary to accomplish work for which the vehicle was designed (such as operating a crane, mixing concrete, etc.).
5. Idling required to bring the machine system to operating temperature.
6. Emergency vehicles, utility company, construction, and maintenance vehicles where the engines must run to perform needed work.
7. Idling to ensure safe operation of the vehicle.
8. Idling when the propulsion engine is providing auxiliary power for other than heating or air conditioning. (such as hydraulic systems for pavers)
9. When specific traffic, safety, or emergency situations arise.
10. If the ambient temperature is less than 32 degrees Fahrenheit. Limited idling to provide for the safety of vehicle occupants (e.g. to run the heater).
11. If the ambient temperature is greater than 90 degrees Fahrenheit. Limited idling to provide for the safety of vehicle occupants of off-highway equipment (e.g. to run the air conditioning) no more than 30 minutes.

12. Diesel powered vehicles may idle for up to 30 minutes to minimize restart problems.

Any vehicle, truck, or equipment in which the primary source of fuel is natural gas or electricity is exempt from the idling limitations set forth in this special provision.

FUEL PRICE ADJUSTMENT PAPER BID:

(11-15-05) (Rev. 1-16-24)

109-8

SP1 G44

Revise the *Standard Specifications* as follows:

Page 1-82, Article 109-8, FUEL PRICE ADJUSTMENTS, add the following:

The base index price for DIESEL #2 FUEL is **\$2.2387** per gallon. The base price is the average terminal price for the first day of October. The base price for this contract shall persist through all renewals. The fuel price adjustment will be administered based on shoulder miles mown during that month. The monthly updated fuel price for adjustments during the course of this contract, including renewals, can be found at:

<https://connect.ncdot.gov/projects/construction/Pages/Pavement-Construction-Prices.aspx>.

The fuel adjustment factor was derived from industry-provided fuel consumption on routine and cleanup mowing for all systems. This factor was validated using NCDOT fuel usage for mowers.

The following formula will be used to calculate the appropriate payment:

$$S = (A - B) \times Q \times F$$

Where:

S = Monthly Fuel Price Adjustment

B = Base Index Price

A = Average Terminal Price

Q = SHM completed during each period

F = Fuel factor for contract item

The items of work and the fuel factor used in calculating adjustments to be made are as follows:

B = 2.2387

A = Varies by month

Q = Varies by month

F = 1.6

Should the contract be extended, the base index price shall persist through all renewals.

PROJECT SPECIAL PROVISIONS

GENERAL TERMS AND CONDITIONS

ACCEPTANCE AND REJECTION

The right is reserved by NCDOT to accept or reject any and all bids or to waive any informality in bids. In case of error in the extension of prices in the bid, unit prices will govern.

COMPETITIVE BIDS

In compliance with 23 U.S.C. § 112, the signer of this bid certifies this bid has not been arrived at collusively nor otherwise in violation of Federal or North Carolina antitrust laws. All bids must be signed by the owner or an officer of the firm.

AWARD OF CONTRACT

“The North Carolina Department of Transportation, in accordance with the provisions of *Title VI of the Civil Rights Act of 1964* (78 Stat. 252) and the Regulations of the Department of Transportation (*49 C.F.R., Part 21*), issued pursuant to such act, hereby notifies all bidders that it will affirmatively insure that the contract entered into pursuant to this advertisement will be awarded to the lowest responsible bidder without discrimination on the ground of race, color, or national origin”.

All qualified proposals will be evaluated by NCDOT to constitute the best value offered for the purpose intended. Responsible bidders will be determined considering the following items:

- A. Related Work Experience
- B. Equipment
- C. Financial Stability
- D. References
- E. Price

The bidder may be required to furnish supporting documentation for items A, B, C, and D. The lowest responsible bidder will be notified if their proposal has been accepted, and the contract awarded. If awarded the contract, the bidder will be expected to perform the work. Withdrawal of proposal will be allowed only under limited conditions. Failure to perform may result in the bidder being held in default of contract. The Department will then proceed to the second lowest bidder and may charge the low bidder who is in default with the additional cost of obtaining those services.

All awards are final and are not subject to further review. Any formal complaints concerning awards should be made in writing to the Engineer.

PAYMENT AND RETAINAGE

Payment to the Contractor will be made only for the actual quantities of the various items that are completed and accepted in accordance with the terms of the contract. Payment to the Contractor will be made monthly. Terms shall be payable upon receipt of approved invoice. If the Contractor and the Engineer agree, payment may be made by cycle. However, fuel price adjustments to payment will be based on work performed in a calendar month.

Requests for payment shall be made by Contractor's Invoice. All invoice items and unit costs shall correspond to contract pay items. In the event of error or discrepancy in items or unit costs, the Department may return the invoice to the Contractor for correction. To avoid confusion and delay of payments each invoice should have a unique Invoice Number, i.e. 1, 2, 3.... In addition, the invoice should be positively identified and associated with the Purchase Order including the **Purchase Order Number and the County the work was completed in** on the invoice. The invoice shall be completely and legibly filled out with all appropriate information and shall be signed by an authorized representative of the Contractor.

All invoices shall be original and submitted to the Division Roadside Environmental Engineer for approval. Statements of all Subcontractor payments shall be included with invoices. These statements are to be submitted on the Subcontractor Payment Information Form (DBE-IS), they shall be original and in ink.

Payment will not be made until invoices and DBE-IS forms are received. Invoices should be received by the Department within 30 days of the completion of the work.

If bonds were not provided, retainage will be withheld. The Department reserves the right to withhold payment for a specific location until after successful completion of the work as verified by the final inspection of that location.

All work or items, other than those listed on the Bid Form contained in the Contract Proposal, necessary to complete this work will be considered incidental in nature and no further compensation will be made.

CONTRACTOR

INSURANCE REQUIREMENTS

The Contractor shall maintain all legally required insurance coverage, including without limitation, worker's compensation and vehicle liability, in the amounts required by law. Refer to Section 107-15 in the "Standard Specifications for Roads and Structures, 2024" for additional information.

SUPERVISION

At all times that work is actually being performed, the Contractor shall have available on the project one competent individual who has been authorized to act in a supervisory capacity over all work. In the event a project is clustered and consists of two or more counties, a supervisor may be required for each county, as the Engineer may consider necessary. The individual who has been so authorized shall be experienced in the type of work being performed and is to be fully capable of managing, directing, and coordinating the work; of reading and thoroughly understanding the contract; and of receiving and carrying out directions from the Engineer or their authorized representatives.

The appointed Supervisor(s) name and contact information shall be shared with the Engineer prior to beginning the first mowing cycle of each year covered under this contract. Each Supervisor shall have a cellular telephone for communication with the Engineer/Inspector for the project. In the event a Supervisor changes telephone numbers advance notice must be given to the Engineer.

At least one (1) English speaking employee must be on-site during the mowing operation.

PROSECUTION OF WORK

The Contractor will be notified by the Engineer as to when to begin operations for each cycle or portion thereof and for any additional work, and the Contractor shall begin work and complete the work within the time frame specified in the Project Special Provisions. Any work performed prior to the time of notification by the Engineer will not be included in any payment to the Contractor. The Contractor will be required to prosecute the work in a continuous and uninterrupted manner. Any portion of routes that do not need to be mown in a subject cycle will be designated by the Engineer and deleted from that cycle. No payment will be made for portions of routes that are not mown.

OPERATION OF EQUIPMENT

All personnel shall be properly trained and qualified to operate the piece of equipment to which they are assigned. The Contractor shall operate the equipment in a safe manner so as not to create a hazard to the traveling public. Insofar as possible, the tractor wheels are to remain off the travel way during mowing operations. The equipment shall not be parked within the State Highway System right of way overnight or at other times when work has been suspended, unless approved by the Engineer.

RESPONSIBILITY FOR DAMAGE CLAIMS

The Contractor shall indemnify NCDOT and its officers, agents, and employees from all suits, actions or claims by any character brought for any injury or damages received or sustained by any person, persons, or property by reason of any act of the Contractor, its agents or employees, in the performing of the contract. Refer to Section 107-14 in the “*Standard Specifications for Roads and Structures*” for additional information.

PROTECTION AND RESTORATION OF PROPERTY

The Contractor shall be responsible for the protection from their activities of all public and private property on and adjacent to the work and shall use every reasonable precaution necessary to prevent damage or injury thereto. Suitable precautions shall be taken to prevent damage to pipes, conduits, and other underground structures, and to poles, wires, cables, and other overhead structures.

The Contractor shall conduct operations so as to prevent damage to roadway delineators and signs. Should any essential sign (YIELD, ONE WAY, etc.) suffer more than minor damage, the Engineer shall be notified no later than the end of that work day. Damage to STOP signs shall be reported immediately. Such signs will be repaired or replaced by the Department at the Contractor's expense. Damage to other signs, delineators, etc. may be repaired or replaced by the Contractor subject to approval by the Engineer or they may be repaired or replaced by the Department at the Contractor's expense.

The Contractor shall protect carefully from disturbance or damage all land monuments and property markers.

The Contractor shall be responsible for the removal, preservation, and resetting of all mailboxes disturbed by the mowing operations. The mailboxes and their supports, when reset, shall be left in as good a condition as they were prior to the mowing operations.

The Contractor will be held responsible for all damage or injury to property of any character resulting from any act, omission, negligence, or misconduct in the prosecution of the work. When any direct or indirect damage or injury is done to public or private property by or on account of any act, omission, negligence, or misconduct in the execution of the work, the Contractor shall either restore at their own expense such property to a condition similar or equal to that existing before such damage or injury was done, or shall make good such damage or injury in a manner acceptable to the owner of the damaged property and to the Department. In case of failure on the part of the Contractor to restore such property or make good such damage or injury the Department may at the Contractor's expense repair, rebuild, or otherwise restore such property in such manner as the Engineer may consider necessary.

GENERAL INFORMATION***STATE HIGHWAY SYSTEM***

The State Interstate System shall include all portions of the State Highway System designated by Interstate Numbers. The State Primary System shall include all portions of the State Highway System which are designated by N.C. or U.S. numbers. The State Secondary Paved and Unpaved System shall include all of the State Highway System designated by SR numbers.

POLICY

It is the policy of NCDOT to maintain State Highway System roadsides in a pleasing and safe condition commensurate with the function and service rendered by individual highway segments. It is intended that grass height within established mowing zones will be maintained between the height shown in the Project Special Provisions and eighteen (18) inches along interstate, primary and major paved secondary routes. Along minor paved and unpaved secondary routes, grass heights may exceed eighteen (18) inches for varying periods of time; however, safe sight distances will be maintained.

HERBICIDAL TREATMENTS

The Department may elect to use herbicidal treatments on some portions of the State Highway System. Generally, the need for mowing of these sections will be reduced during the mowing season. No payment will be made for mowing these sections unless mowing is specifically authorized by the Engineer.

SIGNING

The Contractor will furnish and erect appropriate advance warning signs which are to be kept appropriately spaced. The Engineer will determine the specific requirements for signing. A detail for the advance warning signs is shown in the Appendix.

HOURS OF WORK

The Contractor's operations will be restricted to daylight hours and no work may be performed on Sundays, legal State holidays, holiday weekends, special event, or any other time when traffic is unusually heavy unless otherwise approved by the Engineer. Work shall only be performed when visibility conditions allow safe operations.

THREATENED AND ENDANGERED SPECIES

Due to federal or state listed threatened and endangered species located in the county in which this project may be located, the Contractor will be required to contact the Division Environmental Officer to determine if any part of this project or any area of operations in connection therein is within an area designated as a threatened and endangered plant species population. If so, the Contractor shall be responsible for any damage done to these plant populations as a result of this contract work. The Contractor is responsible for all cost resulting from penalties or fines as well as cost associated with any repair or mitigation work necessary as a result of such damage. All associated cost will be assessed to the contractor and withheld from the contractor payment. The NCDOT sign designating threatened and endangered plant species sites is shown in the Appendix.

Threatened and endangered plant populations may consist of plant groups located one half mile or more apart. Population numbers are subject to change as new populations are discovered, some die off, and occasionally nearby groups of plants are combined into one population for tracking purposes.

Information on each county can be found at this website:

<https://connect.ncdot.gov/resources/roadside/Pages/Field-Operations.aspx>

PLANT AND PEST QUARANTINES

(Imported Fire Ant, Gypsy Moth, Witchweed, Emerald Ash Borer, Guava Root Knot Nematode, And Other Noxious Weeds)

WITHIN QUARANTINED AREA

This project may be within a county regulated for plants and/or pests. If the project or any part of the Contractor's operations is located within a quarantined area, equipment must be thoroughly cleaned prior to moving out of the quarantined area. Comply with federal/state regulations by obtaining a certificate or limited permit for any regulated article moving from the quarantined area.

ORIGINATING IN A QUARANTINED COUNTY

Obtain a certificate or limited permit issued by the N.C. Department of Agriculture/United States Department of Agriculture. Have the certificate or limited permit accompany the article when it arrives at the project site.

CONTACT

Contact the N.C. Department of Agriculture/United States Department of Agriculture at 1-800-206-9333, 919-707-3730, or <http://www.ncagr.gov/plantindustry/> to determine those specific project sites located in the quarantined area or for any regulated article used on this project originating in a quarantined county.

REGULATED ARTICLES

1. Soil, sand, gravel, compost, peat, humus, muck, and decomposed manure, separately or with other articles. This includes movement of articles listed above that may be associated with cut/waste, ditch pulling, and shoulder cutting.
2. Plants with roots including grass sod.
3. Plant crowns and roots.
4. Bulbs, corms, rhizomes, and tubers of ornamental plants.
5. Hay, straw, fodder, and plant litter of any kind.
6. Clearing and grubbing debris.
7. Used agricultural cultivating and harvesting equipment.
8. Used earth-moving equipment.
9. Any other products, articles, or means of conveyance, of any character, if determined by an inspector to present a hazard of spreading imported fire ant, gypsy moth, witchweed, emerald ash borer, guava root knot nematode, or other noxious weeds.

Quarantine information on each county regarding the regulated status of imported fire ant, witchweed and other noxious weeds, gypsy moth, emerald ash borer, and guava root knot nematode can be found at this website:

<http://www.ncagr.gov/plantindustry/Plant/quaran/table2.htm>

Information on emerging pests in North Carolina and surrounding states can be found at this website:

<http://www.ncagr.gov/plantindustry/plant/entomology/alert.htm>

GENERAL SPECIFICATIONS**MOWING**

The mowing pattern along each roadway shall be determined by the Engineer. Typical mowing patterns for this contract are depicted in the Appendix.

ROUTINE MOWING

Routine mowing includes the mowing of sight distance areas at intersections, interchanges, and along curves. On divided highways, mowing in the median shall be performed in accordance with established mowing patterns.

CLEANUP MOWING

Cleanup mowing within the right of way includes the area established for routine mowing and extends beyond these limits to the right-of-way line or to established mowing patterns/tree/wood line.

Cleanup mowing includes the mowing of sight distance areas at intersections, interchanges, and along curves. On divided highways, mowing in the median shall be performed in accordance with established mowing patterns.

CYCLE

One cycle is typically one complete mowing per State Highway System.

VEGETATION REMOVAL AT STATIONARY OBJECTS (TRIMMING)

DESCRIPTION

The Contractor shall perform string/blade trimming of vegetation around and under stationary objects including but not limited to guardrail/guiderail signs, post reflectors, and light poles along the median and shoulder. All vegetation shall be trimmed cleanly and evenly to the height required by the Engineer without damaging the grass, existing surface, or adjacent fixtures.

The Contractor shall perform trimming such that the Contractor shall cut all vegetation accessible by foot. The Contractor shall cut undesirable weeds, vine, shrubs, and any other herbaceous and woody growth. The remaining cut vegetation shall be a maximum height of three (3") for grass and weedy vegetation and a maximum height of one inch (1") for woody vegetation. For any cut woody vegetation, the Contractor shall both remove the cut woody vegetation from the right-of-way and dispose of it properly.

Vegetation Removal at Stationary Objects includes any guardrail/guiderail running linear footage up to and including any guardrail attachment to a bridge. The scope of trimming around guardrail will extend from the guardrail face to the edge of pavement, underneath the guardrail, and from the back of guardrail to the shoulder point, or to the extent of grass left uncut by standard mowers during each cycle in which guardrail trimming occurs. Where guardrail is on a slope that mowers cannot traverse, vegetative trimming shall extend down the slope for five feet (5') along the surface of the ground. The scope of trimming around cable guiderail will extend to the extent of grass left uncut by standard mowers during each cycle in which guiderail trimming occurs. The running linear footage includes trimming of both sides and under the guardrail/guiderail.

Vegetation surrounding other fixed objects, including but not limited to signs, post reflectors, and light poles, etc. within the mowing limits shall be trimmed from the base of the object to the extent of regular mowing. Measurement will be made by square feet for Additional Vegetation Removal at Stationary Objects.

Additional Vegetation Removal at Stationary Objects may also be used in areas where the median is enclosed, crossover areas, or other areas inaccessible to mowers, as directed by the Engineer.

Vegetation shall be removed from edge of pavement up to and around guardrail when vegetated shoulder is four foot (4') or less and one foot (1') past the toe of existing slope.

The extent of trimming at ramps shall include the side road starting a minimum of 150 feet before the ramp connection carrying across the main roadway facility.

The operators must be skilled in the operation of the string trimmer and shall follow all OSHA guidelines. Operators shall wear vision and hearing protection and clothing to provide sufficient protection from flying chips, etc. Operators shall wear an ANSI/ISEA 107-2004 Class 2 safety vest, closed-toe shoes, shirts with sleeves, and long pants.

The Contractor must complete one (1) trimming area prior to moving to the next (**not to exceed over 5 miles**).

The Contractor or his representative must sign daily log sheets prepared in duplicate by the Engineer (listing the dates, hours, descriptions and locations of all work performed) before payment can be made.

LITTER/DEBRIS REMOVAL

DESCRIPTION

An abundance of non-organic trash in a multitude of forms is deposited daily along the roadsides of the designated highways. These conditions detract from the visual quality and/or safety of the roadside landscape.

The work covered by this provision shall include the pickup, removal and recycling of litter/debris and the disposal of same into state approved landfills and single-stream recycling facilities. Litter/debris items may consist of varied sizes of bottles, cans, paper, tires, tire pieces, lumber, vehicle parts, building supplies, metals, household furnishings, cardboard, plastics, ladders, brush and other items not considered normal to the right of way. Designated areas shall

include the median and shoulders in the entire right-of-way from fence line to fence line, all interchange ramps, and mowing areas as well as non-mowing areas. The designated area on shoulders is the white edge line to the back of the right of way on outside shoulders, which includes paved shoulders. The designated area in medians is from yellow edge line to yellow edge line, which includes paved shoulders, **except for along concrete barrier walls in medians. (Litter crew and vehicles are not allowed against median concrete barrier walls).**

This item includes all traffic control necessary to provide a safe work area. The work shall include the furnishing of all equipment, tools, materials, transportation and labor necessary for the successful completion of the work.

No separate payment will be made for providing, installing, and maintaining traffic control devices, etc., or for any other cost associated with maintaining the control of traffic. Traffic control will be considered incidental to the contract, and will be included in the Bid Items as listed on the Contract Bid Form.

Mowing operators shall avoid impacting collected bags of litter. The Contractor shall be responsible for gathering and removing any litter resulting from such an impact for no additional compensation in a manner determined by the Engineer.

The Contractor should be prepared for removing litter/debris in roadside conditions including but not limited to wet areas, standing water, high grass, and slopes. Contractor will not be responsible for removing litter/debris in wooded areas or back slopes unless litter is visible from the roadway and/or ramps.

The operation of litter/debris pickup shall be on foot only. Vehicles as specified herein may be used for bag pickup.

PROSECUTION AND PROGRESS

The Contractor must complete one (1) litter/debris pickup area prior to moving to the next (**not to exceed over 5 miles**).

The Contractor shall provide adequate personnel and materials (litterbags) to remove litter/debris on all areas of the right-of-way or controlled access.

The Contractor shall be responsible for locating and utilizing approved local landfills and recycling facilities so as not to impede the progress of the cleanup operation.

All collected litter/debris shall be containerized immediately and kept off of the traveled portions of the roadway, shoulders, and right-of-way (including paved shoulders) during that day's collection process. All collected litter that is small enough to be placed in a bag shall be bagged immediately. All collected litter that is too large for a bag shall be placed into a vehicle. Uncollected storage or stockpiling of litter/debris and recyclables (piles of litterbags, tires, tire debris, etc.) will not be permitted.

All cost involved with the disposal of the litter/debris shall be included in the contract unit price for "Litter/Debris Removal".

The Contractor's personnel shall dispose of any litter/debris, not required to be recycled, in a landfill approved by North Carolina Division of Waste Management. The Contractor may recycle at any public or commercial recycling facility. Litter/debris may consist of any item not considered normal to the right-of-way. The Contractor will not be allowed to use NCDOT accounts at the landfills/recycling centers nor be allowed to dispose of the litter/debris in NCDOT trash containers on any NCDOT property.

This contract shall be immediately terminated if the contractor is found guilty of illegal dumping. Work will be suspended if contractor is charged with illegal dumping.

RECYCLING

In accordance with the General Statutes and the Department's emphasis on recycling, the Contractors are encouraged to wherever possible to separate trash and recyclables such as glass, aluminum, and other products, and appropriately dispose of each material.

REPORTING

The Contractor shall report online the amount of bags of litter/debris and recycling on the NCDOT Litter Management Website:

<https://apps.ncdot.gov/LM>

The Contractor is required to report all pickups on the date of the pickup.

NOTE: Litter pickup on shoulder miles invoiced must be reported before payment will be made.

HAZARDOUS, CONTAMINATED, AND / OR TOXIC MATERIAL

The Contractor's personnel shall not be responsible for removing hazardous materials from the right-of-way, but shall notify an NCDOT representative as soon as possible.

When the Contractor's operations encounter or expose any abnormal condition which may indicate the presence of a hazardous, contaminated, and/or toxic material, such operations shall be discontinued in the vicinity of the abnormal condition and the Engineer shall be notified immediately.

The Contractor will not be responsible for the cleanup and removal of dead animals. If this situation is encountered, the Contractor shall contact the Engineer as directed.

DELETION OF SECTIONS

In the event that the litter removal (complete corridor or outside shoulder only) for sections of road becomes a part of either the Adopt-A-Highway or Sponsor-A-Highway Program, those sections of road may be deleted from the appropriate list at the direction of the Department in compliance with Section 104-6 of the Standard Specifications. Additional compensation as provided in Section 104-5 of the Standard Specifications does not apply. The section may be re-inserted in the list at the direction of the Department.

It is understood that during the course of the contract, portions of the routes may be deleted from the contract (due to construction projects, Adopt-A-Highway, Sponsor-A-Highway Program, etc.). It will be the responsibility of the Contractor to clean or not clean such sections as directed by the Engineer.

INSPECTION, ACCEPTANCE, MEASUREMENT, AND PAYMENT***INSPECTION***

All work shall be subject to inspection by the Engineer at any time. The Engineer will make periodic inspections of the completed work. It will be the responsibility of the Contractor to keep the Engineer informed of the proposed work plan, and to submit written reports of work accomplished on a weekly basis, unless otherwise directed.

QUALITY AND BASIS OF ACCEPTANCE

For mowing, it is intended that the work will be completed in a neat, workmanlike manner. Areas which are gapped or rolled down and uncut will not be considered acceptable. Vegetation around mailboxes, structures, delineators, mailboxes, guardrail, and sign posts, shall be mown to provide a neat appearance; however, the Contractor will not be required to perform hand trimming, notwithstanding any payable line items specifically requiring hand trimming.

For trimming, it is intended that the work will be completed in a neat, continuous, and uninterrupted manner as determined by the Engineer. Remaining vegetation shall be at the height specified.

For litter/debris removal, it is intended that the work will be completed in a neat, continuous, and uninterrupted manner as determined by the Engineer. Completed work shall be clean and free of all accumulated litter/debris immediately after litter/debris removal. The Contractor shall notify the NCDOT by email when litter collection and trash bag removal is completed.

METHOD OF MEASUREMENT

The quantity of Cleanup Mowing to be paid for will be the actual number of shoulder miles mown. The quantity of Litter and Debris Removal and On Call Litter and Debris Removal to be paid for will be the actual number of cleaned shoulder miles. Highway mileage will be determined from NCDOT county maintenance maps; except in the case of dispute or obvious error, where actual mileage shall be measured. Normally, one map mile of two-lane or multi-lane undivided highway shall equal two (2) shoulder miles, and one map mile of multi-lane divided highways with grassed median shall equal four (4) shoulder miles. All roadway ramps (Entrance and Exit) connecting the main roadway to adjacent roadways shall be mown as part of this contract. No additional measurement or compensation will be made for interchange ramps, sight distance, etc. as such areas are considered incidental to the shoulder miles measured along the mainline.

It is understood that during the course of the contract, routes may be added to or deleted from the contract as routes are added to or deleted from the State Highway System, or for other extenuating circumstances. It will be the responsibility of the Contractor to perform work on such routes as directed by the Engineer. In the case of roads added to the System, actual mileage will be used for measurement. In the event that a road rehabilitation or improvement project is under construction, that section of road may be deleted at the direction of the Department. The section may be re-inserted in the list following completion of the road rehabilitation or improving project.

The quantity of Vegetation Removal at Stationary Objects will be measured and paid for as the actual number of linear feet measured along the guardrail/guiderail (adjacent to and within 1' of) that has been acceptably trimmed. No separate measurement will be made for trimming around sign posts and reflector posts that fall in the footprint of trimming for guardrail/guiderail as such trimming will be considered part of the per linear foot payment.

The quantity of Additional Vegetation Removal at Stationary Objects will be measured and paid for as the actual number of square feet that has been acceptably trimmed. Measurement will be made along the ground surface of the miscellaneous areas trimmed.

BASIS OF PAYMENT

The quantity of Cleanup Mowing, measured as provided above, will be paid for at the contract unit price per shoulder mile for "Mowing - Cleanup" for the various highway systems

The quantity of Vegetation Removal at Stationary Objects, measured as provided above, will be paid for at the contract unit price per linear foot for "Vegetation Removal at Stationary Objects". The quantity of Additional Vegetation Removal at Stationary Objects, measured as provided above, will be paid for at the contract unit price per square foot for "Vegetation Removal at Stationary Objects - Additional".

The quantity of Litter and Debris Removal, measured as provided above, will be paid for at the contract unit price per shoulder mile for "Litter/Debris Removal" for the various highway systems.

Bid prices and payments will be full compensation for all work, including but not limited to supervision, labor, disposal fees, transportation, fuels, lubricants, repair parts, equipment, machinery, and tools, necessary for the prosecution and completion of the work. Payments will be made to the Contractor on a monthly basis for work accomplished and accepted.

EQUIPMENT

The Contractor shall furnish equipment of sufficient type, capacity, and quantity to safely and efficiently perform the work as specified herein. The Contractor's company name, identification number, and telephone number shall be conspicuously and legibly displayed on each tractor, litter removal vehicle, and Service Vehicle.

The Contractor shall furnish the minimum quantity of fully-operated mowers shown in the Project Special Provisions dedicated to the work outlined herein.

The Contractor must demonstrate to the satisfaction of the Engineer that the mowing equipment to be used in the work is in good working condition (i.e. no excessive fluid leaks; blades sharpened and in good condition) and suitable for

performing the work required. All tractors shall have sufficient horsepower to operate their mowers per manufacturer recommendations. All tractor tires shall have adequate tread depth to perform the work required. All equipment safety devices as were originally designed/provided by the manufacturer shall be in place.

The Engineer may reject any equipment that is not operating in a satisfactory manner. Reasons for rejection shall include but not be limited to excessive leaks, tractors that cannot be operated in both forward and reverse gear, and mower attachments that are not capable of acceptable mowing. Contractor shall make arrangements for equipment replacement/repair as needed to satisfy the contract objective. No extension in contract times will be allowed due to rejected equipment.

The Contractor shall be responsible for the equipment provided in this contract at all times and at all locations during the term of the contract. The Contractor shall have no claim against the Department of Transportation for any expense involving damage or loss to the Contractor's equipment (including vandalism, theft, fire and acts of God, etc.) arising out of, or relating to, work performed under this agreement.

SAFETY, LIGHTING, AND SIGNAGE

All tractors shall be equipped so as to conform to the prevailing Occupational Safety Health Act Standards.

The Contractor must furnish, mount, and maintain a W10-11 or W10-11A "CAUTION MOWER" sign on the rear of each mower such that they can be easily read by motorists approaching from the rear. Both sign types are black lettering over a fluorescent orange background. The sign shall have a minimum clearance of one (1) foot from the ground to the bottom of the sign. The sign must not obstruct any safety lighting or the operator's view.

All tractors shall be equipped with one (1) light bar mounted on top of the cab/canopy. The width of the bar shall be seventeen (17) inches or greater, but shall not exceed safe mounting limits of the cab. The bar's light source may be a series of rotating quartz-halogen, incandescent, or LED bulbs; stroboscopic lamps; or static programmable LED. The Engineer may require an alternate pattern should the one chosen be deemed unsafe, inconsistent, or inadequate. The light source shall be amber in color as permitted by N.C.G.S § 20-130.2. The light bar shall be visible from all directions.

The Contractor may choose to elevate the rear-mounted "CAUTION MOWER" sign above the operator for increased visibility to approaching traffic. Since such an elevation would obstruct the view of any single light bar, the Contractor may use two (2) additional overhead stroboscopic perimeter lights instead of the light bar. These lights must be securely attached to the cab, canopy, roll bar, or sign. The lights must be fully viewable from the front and back of the tractor. If mounting placement precludes visibility of the lights from the front and back, additional perimeter lights must be used to attain full visibility of the lights from the front and the back. The elevated sign must not obstruct the rear-view of the operator.

All tractors shall be equipped with one (1) perimeter light mounted on the left rear fender, and one (1) perimeter light mounted on the right rear fender and be visible from the front and rear. These lights shall be amber in color.

60" – 90" MOWERS

Tractors shall be equipped with rear-mounted rotary or flail mower and a side-mounted rotary, or flail mower; unless otherwise specified or restricted in the Project Special Provisions. When used in combination, the mowers shall overlap. Rear mounted mowers shall have a minimum cutting width of sixty (60) inches.

FLEXIBLE WING MOWERS

When permitted by the Engineer, the Contractor may use tow-behind flexible wing rotary mowers with one or two side "wings". When in operation, all cutting paths shall have a minimum overlap of six (6) inches. Mowers with one wing shall have a minimum cutting swath of ten (10) feet; mowers with two wings shall have a minimum cutting swath of fifteen (15) feet. All discharge paths shall be properly shielded by solid plates or chains in accordance with manufacture specification.

STRING TRIMMERS

The Contractor shall furnish equipment of sufficient type, capacity, and quantity to safely and efficiently perform the work. String trimmers shall be commercial grade, gasoline powered units with a minimum cut diameter of seventeen inches (17").

LITTER/DEBRIS REMOVAL VEHICLES

Litter/debris removal vehicles shall meet all service vehicles specifications. Side by side utility vehicles with beds capable of carrying litter bags with specified warning lights may be allowed for bag pickup only. Four wheeler vehicles will not be allowed.

The Contractor must furnish, mount, and maintain a W10-11 or W10-11A "DEBRIS PICK UP FREQUENT STOPS" sign on the rear of each litter and debris removal vehicle or trailer such that they can be easily read by motorists approaching from the rear. Details of the sign is included in the appendix of this proposal. The sign must not obstruct any safety lighting or the operator's view.

SERVICE VEHICLES

All vehicles used by the Contractor must be performance worthy by visual and operational inspection. All vehicles, including trailers, used should be properly equipped with lighting per Roadway Standard Drawing 1165.01 Sheet 1 of 1. Trailers shall have rear mounted strobe lights, mounted as high as possible to enhance visibility.

The safety of the public and the convenience of traffic shall be regarded as prime importance. The Contractor shall operate the equipment in a safe manner so as not to create a hazard to the traveling public. Crossing lanes of traffic and erratic driving will be strictly prohibited.

Signs, lights, safety, and other traffic control items are not a pay item, but are considered incidental to other contract items and the Contractor is expected to provide these items.

TRAFFIC CONTROL AND WORK ZONE SAFETY

In accordance with SSRS 107-21, the Contractor shall comply with all applicable Federal, State, and local laws, ordinances, and regulations governing safety, health, and sanitation, and shall provide all safeguards, safety devices, and protective equipment, and shall take any other needed actions that are reasonably necessary to protect the life and health of employees on the job and the safety of the public, and to protect property in connection with the performance of the work covered by the contract.

Failure to comply with any of the requirements for safety and traffic control of this contract shall result in suspension of work as provided in SSRS 108-7.

Work Zone Traffic Control shall include furnishing, installing, maintaining, relocating and finally removing any and all signs, barricades, drums, cones, flashing arrow boards, truck mounted impact attenuators and all other traffic control devices required to safely perform the work and protect the public.

SAFETY VESTS

All Contractor's personnel, all subcontractors and their personnel, and any material suppliers and their personnel, shall wear an approved reflective safety vest or outer garment meeting ANSI/ISEA 107-2004 Class 2 standards at all times while on the project.

WORK ZONE INSTALLER:

(7-20-21)(Rev. 8-16-22)

1101, 1150

SP11 R04

Provide the service of at least one qualified work zone installer during the setup, installation, and removal of temporary traffic control within the highway right of way. The qualified work zone installer shall serve as crew leader and shall be

on site and directing the installation and removal of temporary traffic control. If multiple temporary traffic control installations or removals are occurring simultaneously, then each shall have a qualified work zone installer.

The work zone installer shall be qualified by an NCDOT approved training agency or other NCDOT approved training provider in the safe and competent set up of temporary traffic control. For a complete listing of approved training agencies, see the Work Zone Safety Training webpage.

A work zone supervisor, in accordance with Article 1101-13 of the *Standard Specifications*, may fulfill the role of the work zone installer during the setup, installation, and removal of temporary traffic control within the highway right of way provided they are on site and directing the installation and removal of temporary traffic control.

All other individuals participating in the setup, installation, and removal of temporary traffic control within the highway right of way shall be certified as a qualified flagger in accordance with Article 1150-3 of the *Standard Specifications*, even if flagging is not being performed as part of the traffic control.

Provide the name and contact information of all qualified work zone installers to the Engineer prior to or at the preconstruction conference. Additionally, provide a qualification statement that all other individuals participating in the setup, installation, and removal of temporary traffic control are qualified flaggers that have been properly trained through an NCDOT approved training agency or other NCDOT approved training provider.

All certification records for qualified work zone installers and flaggers shall be uploaded by the approved training agency or other NCDOT approved training provider to the Department's Work Zone Education Verification App (WZ-EVA) prior to the qualified work zone installer or flagger performing any traffic control duties on the project. For more information about WZ-EVA, see the Work Zone Safety Training webpage.

WORK ZONE SIGNING

All portable signs and stands must meet or exceed the requirements of the National Cooperative Highway Research Program Report 350 for Work Zone Category II Devices, and be listed on North Carolina's approved products list or accepted as traffic qualified by the Traffic Control Section. Use portable work zone signs and stands specifically designed for one another.

Refer to the following:

- SSRS 1089 for material specification
- SSRS 1110 for construction specification
- RSD 1110 for clearance specification

The W10-10A shall be used for high volume primary and secondary routes. Its dimensions are 48" X 48". It shall be mounted at a minimum height of five (5) feet above the elevation of the outermost edge of travel. The sign shall read "MOWING NEXT 10 MILES" for mowing and "LITTER PICKUP NEXT 5 MILES" for litter pickup, and should be relocated accordingly during the prosecution of work.

The W10-10 shall be used for low volume secondary roads. Its dimensions are 36" X 36". However, the Engineer may require a larger 48" X 48" variant if traffic conditions dictate a need. The sign shall read "GRASS MOWING AHEAD" for mowing and "LITTER PICKUP AHEAD" for litter pickup. Low volume secondary routes are typically short enough that initial signage – either at the beginning of the route, or the beginning of the operation – do not need to be relocated within the same route. However, the Contractor may be directed to relocate signs on specified low volume secondary routes for reasons of safety at the Engineer's discretion. If the work zone in question contains a long-arm operation, the sign shall be relocated to maintain a maximum two (2) mile work zone.

MULTI-LANE MEDIAN OPERATIONS

For mowing operations in the median of divided routes, various traffic control devices may be required, including shadow vehicles, TMAs, and lane closures. Refer to the "Multi-lane Operation Diagrams" in the Appendix for a depiction of traffic control devices required based on proximity to the nearest lane of travel. Such traffic control devices

are not considered incidental, and will be paid separately under the line items “TCD Median Guardrail” and “Lane Closure”.

The Contractor may avoid the need for such traffic control devices through situational use of long-arm mowers, or narrow deck mowers if permitted by the Engineer.

DEADHEADING

Deadheading is herein defined as the movement of equipment within the traveled way while not in operation pursuant to the material terms of this contract.

Deadheading may be permitted under the following circumstances:

- Equipment is within a properly signed work zone (refer to “Required Signs” in the Appendix)
- Equipment must briefly enter the traveled way to circumvent an otherwise unavoidable obstacle in the shoulder or median within the right-of-way. This includes traversing bridges. The operator must yield to approaching traffic.
- Equipment using over/under passes in order to continue work on the other side of a route. All such locations should be determined prior to beginning work, and be permitted by the Engineer. The Engineer shall be responsible for notifying other authorities should such movements require the equipment to enter jurisdictions beyond those of the Engineer.

Any deadheading not explicitly permitted under these conditions is forbidden, and such equipment must be transported by trailer.

LITTER/DEBRIS REMOVAL

All stages of the litter/debris removal operation shall be accomplished in accordance with the “Work Zone Traffic Control Guidance for Litter/Debris Removal” as specified. The NCDOT Certified Work Zone Supervisor shall submit traffic control plans for the approval of the Engineer, who may adjust or require additional control measures if warranted.

The Contractor will be held responsible for all damage or injury to property of any character resulting from any act, omission, negligence, or misconduct in the prosecution of the work. When any direct or indirect damage or injury is done to public or private property by or on account of any act, omission, negligence, or misconduct in the execution of the work, the Contractor shall either restore at his/her own expense such property to a condition similar or equal to that existing before such damage or injury was done, or shall make good such damage or injury in a manner acceptable to the owner of the damaged property and to the Department. In case of failure on the part of the Contractor to restore such property or make good such damage or injury the Department may at the Contractor’s expense repair, rebuild, or otherwise restore such property in such manner, as the Engineer may consider necessary.

General:

- Workers that are involved in litter/debris removal operations shall wear NCDOT approved safety vests meeting ANSI/ISEA 107-2004 Class 2 standards for day time operations.
- Litter/debris removal operations shall be confined within a maximum 5 mile stretch of roadway in a work period.
- Conduct litter/debris removal operations behind lane closures at any location where workers and/or equipment are encroaching into the travel lanes. Lane closures shall be installed according to Roadway Standard Drawings 1101.02. Encroaching into travel lanes includes exiting and entering vehicles that are parked on shoulders.
- Use the appendix drawings to retrieve bagged litter/debris and any other materials after being collected by the workers.

- For operations where workers and equipment are confined to the shoulders, comply with the following:

On Multilane Divided Facilities

- A Truck Mounted Attenuator (TMA) shall be used to protect each group of workers removing litter/debris if the shoulder is wide enough to fit a TMA.
- If a TMA is not used, a shoulder closure shall be installed
- A shoulder closure shall be installed in locations where the shoulder is too narrow to accommodate a TMA without encroaching into the traffic lane.
- A shoulder closure or a TMA shall be used on the median side of the opposite direction where workers and/or equipment are within 15' from the adjacent travel lane in the opposite direction and are not protected from traffic in the opposite direction by any type of positive median protection such as concrete barrier, guardrail, or guiderail.
- Shoulder closures shall be installed according to Roadway Standard Drawing 1101.04.

Two-Lane, Two-Way Facilities over 4000 ADT

- A shoulder closure shall be installed if workers are to be present more than one hour at any location.
- If workers are to be present less than one hour, use portable advance warning signs (one in each direction) reading "LITTER PICKUP AHEAD".
- Shoulder closures shall be installed according to Roadway Standard Drawing 1101.04.

Two-Lane, Two-Way Facilities 4000 ADT or lower

- Use portable advance warning signs (one in each direction) reading "LITTER PICKUP AHEAD". The sign should be located 500 feet ahead of the area where workers and or equipment will be present during the operation.

Please Note The Following Exceptions:

The moving caravan operation will NOT be required to be used while retrieving bagged litter/debris in areas where the Contractor's equipment is able to traverse the shoulder without encroaching into the travel lanes.

The truck mounted attenuator (TMA) will NOT be required to be used while retrieving bagged litter/debris in areas where the Contractor's equipment is able to traverse the shoulder without encroaching into the travel lanes.

If the vehicle the Contractor is using is wider than the width of the shoulder a moving caravan operation WILL be required if the Contractor elects to allow the vehicle to encroach into the travel.

The Contractor may elect to park the vehicle outside of these narrow areas and remove bags by hand in lieu of the moving caravan operation.

The truck mounted attenuator (TMA) will NOT be required to protect workers picking up litter/debris if the Contractor's operations are carried out in such a way that the workers are positioned individually along a roadway and not travelling in a concentrated group.

If a concentrated group of workers are gathered together in a formation to conduct clean up then they shall be protected by a TMA.

The shoulder closure will NOT be required unless equipment remains stationary for more than 5 minutes and/or a concentrated group of workers are within 15 feet of an open travel lane and the area is not protected by barrier or guardrail.

The lane closure will NOT be required unless equipment remains stationary for more than five minutes and/or a concentrated group of workers are within 10 feet of an open travel lane and the area is not protected by barrier or guardrail.

A concentrated group of workers is defined as three (3) or more workers within a 500' section and within fifteen (15) feet from a travel lane, measured along the edge of the roadway, of other workers.

MINORITY BUSINESS ENTERPRISE AND WOMEN BUSINESS ENTERPRISE (DIVISIONS):

(10-16-07)(Rev. 5-9-24)

102-15(J)

SP1 G67

Description

The purpose of this Special Provision is to carry out the North Carolina Department of Transportation's policy of ensuring nondiscrimination in the award and administration of contracts financed in whole or in part with State funds.

Definitions

Additional MBE/WBE Subcontractors - Any MBE/WBE submitted at the time of bid that will not be used to meet the Combined MBE/WBE goal. No submittal of a Letter of Intent is required.

Combined MBE/WBE Goal: A portion of the total contract, expressed as a percentage that is to be performed by committed MBE/WBE subcontractors

Committed MBE/WBE Subcontractor - Any MBE/WBE submitted at the time of bid that is being used to meet the Combined MBE / WBE goal by submission of a Letter of Intent. Or any MBE or WBE used as a replacement for a previously committed MBE or WBE firm.

Contract Goal Requirement - The approved participation at time of award, but not greater than the advertised Combined MBE/WBE contract goal.

Goal Confirmation Letter - Written documentation from the Department to the bidder confirming the Contractor's approved, committed participation along with a listing of the committed MBE and WBE firms.

Manufacturer - A firm that owns (or leases) and operates or maintains a factory or establishment that produces on the premises, the materials or supplies obtained by the Contractor. A firm that makes minor modifications to the materials, supplies, articles, or equipment is not a manufacturer.

MBE Participation (Anticipated) - A portion of the total contract, expressed as a percentage that is anticipated to be performed by committed MBE subcontractor(s).

Minority Business Enterprise (MBE) - A firm certified as a Disadvantaged Minority-Owned Business Enterprise through the North Carolina Unified Certification Program.

Regular Dealer - A firm that owns (or leases), and operates a store, warehouse, or other establishment in which the materials or supplies required for the performance of the contract are bought, kept in sufficient quantities, and regularly sold to the public in the usual course of business. A regular dealer engages in, as its principal business and in its own name, the purchase and sale or lease of the products in question. A regular dealer in such bulk items as steel, concrete or concrete products, gravel, stone, asphalt and petroleum products need not keep such products in stock, if it owns and operates distribution equipment for the products. Any supplement of regular dealers' own distribution equipment shall be by a long-term operating lease and not on an ad hoc or contract-by-contract basis.

Distributor - A firm that engages in the regular sale or lease of the items specified by the contract. A distributor assumes responsibility for the items it purchases once they leave the point of origin (e.g., a manufacturer's facility), making it liable for any loss or damage not covered by the carrier's insurance.

Replacement / Substitution - A full or partial reduction in the amount of work subcontracted to a committed (or an approved substitute) MBE/WBE firm.

North Carolina Unified Certification Program (NCUCP) - A program that provides comprehensive services and information to applicants for MBE/WBE certification. The MBE/WBE program follows the same regulations as the federal Disadvantaged Business Enterprise (DBE) program in accordance with 49 CFR Part 26.

United States Department of Transportation (USDOT) - Federal agency responsible for issuing regulations (49 CFR Part 26) and official guidance for the DBE program.

WBE Participation (Anticipated) - A portion of the total contract, expressed as a percentage that is anticipated to be performed by committed WBE subcontractor(s).

Women Business Enterprise (WBE) - A firm certified as a Disadvantaged Women-Owned Business Enterprise through the North Carolina Unified Certification Program.

Forms and Websites Referenced in this Provision

Payment Tracking System - On-line system in which the Contractor enters the payments made to MBE and WBE subcontractors who have performed work on the project. <https://apps.dot.state.nc.us/Vendor/PaymentTracking/>

DBE-IS Subcontractor Payment Information - Form for reporting the payments made to all MBE/WBE firms working on the project. This form is for paper bid projects only. <https://connect.ncdot.gov/business/Turnpike/Documents/Form%20DBE-IS%20Subcontractor%20Payment%20Information.pdf>

RF-1 MBE/WBE Replacement Request Form - Form for replacing a committed MBE or WBE.

<https://connect.ncdot.gov/projects/construction/Construction%20Forms/DBE%20MBE%20WBE%20Replacement%20Form%20and%20Instructions.pdf>

SAF Subcontract Approval Form - Form required for approval to sublet the contract.

<https://connect.ncdot.gov/projects/construction/Construction%20Forms/SAF%20Form%20-%20Subcontract%20Approval%20Form%20Revised%2004-19.xlsm>

JC-1 Joint Check Notification Form - Form and procedures for joint check notification. The form acts as a written joint check agreement among the parties providing full and prompt disclosure of the expected use of joint checks.

<http://connect.ncdot.gov/projects/construction/Construction%20Forms/Joint%20Check%20Notification%20Form.pdf>

Letter of Intent - Form signed by the Contractor and the MBE/WBE subcontractor, manufacturer or regular dealer that affirms that a portion of said contract is going to be performed by the signed MBE/WBE for the estimated amount (based on quantities and unit prices) listed at the time of bid.

<http://connect.ncdot.gov/letting/LetCentral/Letter%20of%20Intent%20to%20Perform%20as%20a%20Subcontractor.pdf>

Listing of MBE and WBE Subcontractors Form - Form for entering MBE/WBE subcontractors on a project that will meet the Combined MBE/WBE goal. This form is for paper bids only.

[http://connect.ncdot.gov/municipalities/Bid%20Proposals%20for%20LGA%20Content/09%20MBE-WBE%20Subcontractors%20\(State\).docx](http://connect.ncdot.gov/municipalities/Bid%20Proposals%20for%20LGA%20Content/09%20MBE-WBE%20Subcontractors%20(State).docx)

Subcontractor Quote Comparison Sheet - Spreadsheet for showing all subcontractor quotes in the work areas where MBEs and WBEs quoted on the project. This sheet is submitted with good faith effort packages.

<http://connect.ncdot.gov/business/SmallBusiness/Documents/DBE%20Subcontractor%20Quote%20Comparison%20Example.xls>

DBE Regular Dealer/Distributor Affirmation Form - Form is used to make a preliminary counting determination for each DBE listed as a regular dealer or distributor to assess its eligibility for 60 or 40 percent credit, respectively of the cost of materials or supplies based on its demonstrated capacity and intent to perform as a regular dealer or distributor, as defined in section 49 CFR 26.55 under the contract at issue. A Contractor will submit the completed form with the Letter of Intent.

<https://connect.ncdot.gov/projects/construction/Construction%20Forms/DBE%20Regular%20Dealer-Distributor%20Affirmation%20Form%20-%20USDOT%202024.pdf>

Combined MBE/WBE Goal

The Combined MBE/WBE Goal for this project is zero%

The Combined Goal was established utilizing the following anticipated participation for Minority Business Enterprises and Women Business Enterprises:

(A) Minority Business Enterprises zero %

- (1) *If the anticipated MBE participation is more than zero*, the Contractor shall exercise all necessary and reasonable steps to ensure that MBEs participate in at least the percent of the contract as set forth above.
- (2) *If the anticipated MBE participation is zero*, the Contractor shall make an effort to recruit and use MBEs during the performance of the contract. Any MBE participation obtained shall be reported to the Department.

(B) Women Business Enterprises zero%

- (1) *If the anticipated WBE participation is more than zero*, the Contractor shall exercise all necessary and reasonable steps to ensure that WBEs participate in at least the percent of the contract as set forth above.
- (2) *If the anticipated WBE participation is zero*, the Contractor shall make an effort to recruit and use WBEs during the performance of the contract. Any WBE participation obtained shall be reported to the Department.

The Bidder is required to submit only participation to meet the Combined MBE/WBE Goal. The Combined Goal may be met by submitting all MBE participation, all WBE participation, or a combination of MBE and WBE participation.

Directory of Transportation Firms (Directory)

Real-time information is available about firms doing business with the Department and firms that are certified through NCUCP in the Directory of Transportation Firms. Only firms identified in the Directory as MBE and WBE certified shall be used to meet the Combined MBE / WBE goal. The Directory can be found at the following link.

<https://www.ebs.nc.gov/VendorDirectory/default.html>

The listing of an individual firm in the directory shall not be construed as an endorsement of the firm's capability to perform certain work.

Listing of MBE/WBE Subcontractors

At the time of bid, bidders shall submit all MBE and WBE participation that they anticipate to use during the life of the contract. Only those identified to meet the Combined MBE/WBE goal will be considered committed, even though the listing shall include both committed MBE/WBE subcontractors and additional MBE/WBE subcontractors. Any additional MBE/WBE subcontractor participation above the goal will follow the banking guidelines found elsewhere in this provision. All other additional MBE/WBE subcontractor participation submitted at the time of bid will be used toward the Department's overall race-neutral goals. Only those firms with current MBE and WBE certification at the time of bid opening will be acceptable for listing in the bidder's submittal of MBE and WBE participation. The Contractor shall indicate the following required information:

(A) Electronic Bids

Bidders shall submit a listing of MBE and WBE participation in the appropriate section of the electronic submittal file.

- (1) Submit the names and addresses of MBE and WBE firms identified to participate in the contract. If the bidder uses the updated listing of MBE and WBE firms shown in the electronic submittal file, the bidder may use the dropdown menu to access the name and address of the firms.

- (2) Submit the contract line numbers of work to be performed by each MBE and WBE firm. When no figures or firms are entered, the bidder will be considered to have no MBE or WBE participation.
 - (3) The bidder shall be responsible for ensuring that the MBE and WBE are certified at the time of bid by checking the Directory of Transportation Firms. If the firm is not certified at the time of the bid-letting, that MBE's or WBE's participation will not count towards achieving the Combined MBE/WBE goal.
- (B) Paper Bids
- (1) *If the Combined MBE/ WBE goal is more than zero,*
 - (a) Bidders, at the time the bid proposal is submitted, shall submit a listing of MBE/WBE participation, including the names and addresses on *Listing of MBE and WBE Subcontractors* contained elsewhere in the contract documents in order for the bid to be considered responsive. Bidders shall indicate the total dollar value of the MBE and WBE participation for the contract.
 - (b) If bidders have no MBE or WBE participation, they shall indicate this on the *Listing of MBE and WBE Subcontractors* by entering the word "None" or the number "0." This form shall be completed in its entirety. **Blank forms will not be deemed to represent zero participation.** Bids submitted that do not have MBE and WBE participation indicated on the appropriate form will not be read publicly during the opening of bids. The Department will not consider these bids for award and the proposal will be rejected.
 - (c) The bidder shall be responsible for ensuring that the MBE/WBE is certified at the time of bid by checking the Directory of Transportation Firms. If the firm is not certified at the time of the bid-letting, that MBE's or WBE's participation will not count towards achieving the Combined MBE/WBE goal.
 - (2) *If the Combined MBE/WBE Goal is zero,* entries on the *Listing of MBE and WBE Subcontractors* are not required for the zero goal, however any MBE or WBE participation that is achieved during the project shall be reported in accordance with requirements contained elsewhere in the special provision.

MBE or WBE Prime Contractor

When a certified MBE or WBE firm bids on a contract that contains a Combined MBE/WBE Goal, the firm is responsible for meeting the goal or making good faith efforts to meet the goal, just like any other bidder. In most cases, a MBE or WBE bidder on a contract will meet the Combined MBE/WBE goal by virtue of the work it performs on the contract with its own forces. However, all the work that is performed by the MBE or WBE bidder and any other similarly certified subcontractors will count toward the goal. The MBE or WBE bidder shall list itself along with any MBE or WBE subcontractors, if any, in order to receive credit toward the goals.

MBE/WBE prime contractors shall also follow Sections A or B listed under *Listing of MBE/WBE Subcontractors* just as a non-MBE/WBE bidder would.

Written Documentation – Letter of Intent

The bidder shall submit written documentation for each MBE/WBE that will be used to meet the Combined MBE/WBE goal of the contract, indicating the bidder's commitment to use the MBE/WBE in the contract. This documentation shall be submitted on the Department's form titled *Letter of Intent*.

The documentation shall be received in the office of the Engineer no later than 2:00 p.m. of the fifth calendar day following opening of bids, unless the fifth day falls on Saturday, Sunday or an official state holiday. In that situation, it is due in the office of the Engineer no later than 10:00 a.m. on the next official state business day.

If the bidder fails to submit the Letter of Intent from each committed MBE and WBE to be used toward the Combined MBE/WBE goal, or if the form is incomplete (i.e. both signatures are not present), the MBE/WBE participation will not count toward meeting the Combined MBE/WBE goal. If the lack of this participation drops the commitment below the Combined MBE/WBE goal, the Contractor shall submit evidence of good faith efforts for the goal not met, completed in

its entirety, to the Engineer no later than 2:00 p.m. of the eighth calendar day following opening of bids, unless the eighth day falls on Saturday, Sunday or an official state holiday. In that situation, it is due in the office of the Engineer no later than 10:00 a.m. on the next official state business day.

Banking MBE/WBE Credit

If the committed MBE/WBE participation submitted exceeds the algebraic sum of the Combined MBE/WBE goal by \$1,000 or more, the excess will be placed on deposit by the Department for future use by the bidder. Separate accounts will be maintained for MBE and WBE participation and these may accumulate for a period not to exceed 24 months.

When the apparent lowest responsive bidder fails to submit sufficient participation by MBE and WBE firms to meet the advertised goal, as part of the good faith effort, the Department will consider allowing the bidder to withdraw funds to meet the Combined MBE/WBE goal as long as there are adequate funds available from the bidder's MBE and WBE bank accounts.

Submission of Good Faith Effort

If the bidder fails to meet or exceed the Combined MBE/WBE goal, the apparent lowest responsive bidder shall submit to the Department documentation of adequate good faith efforts made to reach that specific goal.

One complete set and one copy of this information shall be received in the office of the Engineer no later than 2:00 p.m. of the fifth calendar day following opening of bids, unless the fifth day falls on Saturday, Sunday or an official state holiday. In that situation, it is due in the office of the Engineer no later than 10:00 a.m. on the next official state business day.

Note: Where the information submitted includes repetitious solicitation letters, it will be acceptable to submit a representative letter along with a distribution list of the firms that were solicited. Documentation of MBE/WBE quotations shall be a part of the good faith effort submittal. This documentation may include written subcontractor quotations, telephone log notations of verbal quotations, or other types of quotation documentation.

Consideration of Good Faith Effort for Projects with a Combined MBE/WBE Goal More Than Zero

Adequate good faith efforts mean that the bidder took all necessary and reasonable steps to achieve the goal which, by their scope, intensity, and appropriateness, could reasonably be expected to obtain sufficient MBE/WBE participation. Adequate good faith efforts also mean that the bidder actively and aggressively sought MBE/WBE participation. Mere *pro forma* efforts are not considered good faith efforts.

The Department will consider the quality, quantity, and intensity of the different kinds of efforts a bidder has made. Listed below are examples of the types of actions a bidder will take in making a good faith effort to meet the goals and are not intended to be exclusive or exhaustive, nor is it intended to be a mandatory checklist.

- (A) Soliciting through all reasonable and available means (e.g. attendance at pre-bid meetings, advertising, written notices, use of verifiable electronic means through the use of the NCDOT Directory of Transportation Firms) the interest of all certified MBEs/WBEs that are also prequalified subcontractors. The bidder must solicit this interest within at least 10 days prior to bid opening to allow the MBEs/WBEs to respond to the solicitation. Solicitation shall provide the opportunity to MBEs/WBEs within the Division and surrounding Divisions where the project is located. The bidder must determine with certainty if the MBEs/WBEs are interested by taking appropriate steps to follow up initial solicitations.
- (B) Selecting portions of the work to be performed by MBEs/WBEs in order to increase the likelihood that the Combined MBE/WBE goal will be achieved.
 - (1) Where appropriate, break out contract work items into economically feasible units to facilitate MBE/WBE participation, even when the prime contractor might otherwise prefer to perform these work items with its own forces.
 - (2) Negotiate with subcontractors to assume part of the responsibility to meet the advertised goal when the work to be sublet includes potential for MBE/WBE participation (2nd and 3rd tier subcontractors).

- (C) Providing interested certified MBEs/WBEs that are also prequalified subcontractors with adequate information about the plans, specifications, and requirements of the contract in a timely manner to assist them in responding to a solicitation.
- (D)
 - (1) Negotiating in good faith with interested MBEs/WBEs. It is the bidder's responsibility to make a portion of the work available to MBE/WBE subcontractors and suppliers and to select those portions of the work or material needs consistent with the available MBE/WBE subcontractors and suppliers, so as to facilitate MBE/WBE participation. Evidence of such negotiation includes the names, addresses, and telephone numbers of MBEs/WBEs that were considered; a description of the information provided regarding the plans and specifications for the work selected for subcontracting; and evidence as to why additional agreements could not be reached for MBEs/WBEs to perform the work.
 - (2) A bidder using good business judgment would consider a number of factors in negotiating with subcontractors, including MBE/WBE subcontractors, and would take a firm's price and capabilities as well as the advertised goal into consideration. However, the fact that there may be some additional costs involved in finding and using MBEs/WBEs is not in itself sufficient reason for a bidder's failure to meet the advertised goal, as long as such costs are reasonable. Also, the ability or desire of a prime contractor to perform the work of a contract with its own organization does not relieve the bidder of the responsibility to make good faith efforts. Bidding contractors are not, however, required to accept higher quotes from MBEs/WBEs if the price difference is excessive or unreasonable.
- (E) Not rejecting MBEs/WBEs as being unqualified without sound reasons based on a thorough investigation of their capabilities. The bidder's standing within its industry, membership in specific groups, organizations, or associates and political or social affiliations (for example, union vs. non-union employee status) are not legitimate causes for the rejection or non-solicitation of bids in the bidder's efforts to meet the project goal.
- (F) Making efforts to assist interested MBEs/WBEs in obtaining bonding, lines of credit, or insurance as required by the recipient or bidder.
- (G) Making efforts to assist interested MBEs/WBEs in obtaining necessary equipment, supplies, materials, or related assistance or services.
- (H) Effectively using the services of available minority/women community organizations; minority/women contractors' groups; Federal, State, and local minority/women business assistance offices; and other organizations as allowed on a case-by-case basis to provide assistance in the recruitment and placement of MBEs/WBEs. Contact within 7 days from the bid opening the Business Opportunity and Work Force Development Unit at BOWD@ncdot.gov to give notification of the bidder's inability to get MBE or WBE quotes.
- (I) Any other evidence that the bidder submits which shows that the bidder has made reasonable good faith efforts to meet the advertised goal.

In addition, the Department may take into account the following:

- (1) Whether the bidder's documentation reflects a clear and realistic plan for achieving the Combined MBE/WBE goal.
- (2) The bidders' past performance in meeting the contract goal.
- (3) The performance of other bidders in meeting the advertised goal. For example, when the apparent successful bidder fails to meet the goal, but others meet it, you may reasonably raise the question of whether, with additional reasonable efforts the apparent successful bidder could have met the goal. If the apparent successful bidder fails to meet the advertised goal, but meets or exceeds the average MBE and WBE participation obtained by other bidders, the Department may view this, in conjunction with other factors, as evidence of the apparent successful bidder having made a good faith effort.

If the Department does not award the contract to the apparent lowest responsive bidder, the Department reserves the right to award the contract to the next lowest responsive bidder that can satisfy to the Department that the Combined MBE/WBE goal can be met or that an adequate good faith effort has been made to meet the advertised goal.

Non-Good Faith Appeal

The Engineer will notify the Contractor verbally and in writing of non-good faith. A Contractor may appeal a determination of non-good faith made by the Goal Compliance Committee. If a Contractor wishes to appeal the determination made by the Committee, they shall provide written notification to the Engineer. The appeal shall be made within 2 business days of notification of the determination of non-good faith.

Counting MBE/WBE Participation Toward Meeting the Combined MBE/WBE Goal

(A) Participation

The total dollar value of the participation by a committed MBE/WBE will be counted toward the contract goal requirements. The total dollar value of participation by a committed MBE/WBE will be based upon the value of work performed by the MBE/WBE and the actual payments to MBE/WBE firms by the Contractor.

(B) Joint Checks

Prior notification of joint check use shall be required when counting MBE/WBE participation for services or purchases that involves the use of a joint check. Notification shall be through submission of Form JC-1 (*Joint Check Notification Form*) and the use of joint checks shall be in accordance with the Department's Joint Check Procedures.

(C) Subcontracts (Non-Trucking)

A MBE/WBE may enter into subcontracts. Work that a MBE subcontracts to another MBE firm may be counted toward the anticipated MBE participation. The same holds for work that a WBE subcontracts to another WBE firm. Work that a MBE/WBE subcontracts to a non-MBE/WBE firm does not count toward the contract goal requirement. It should be noted that every effort shall be made by MBE and WBE contractors to subcontract to the same certification (i.e., MBEs to MBEs and WBEs to WBEs), in order to fulfill the MBE or WBE participation breakdown. This, however, may not always be possible due to the limitation of firms in the area. If the MBE or WBE firm shows a good faith effort has been made to reach out to similarly certified firms and there is no interest or availability, and they can get assistance from other certified firms, the Engineer will not hold the prime responsible for meeting the individual MBE or WBE breakdown. If a MBE or WBE contractor or subcontractor subcontracts a significantly greater portion of the work of the contract than would be expected on the basis of standard industry practices, it shall be presumed that the MBE or WBE is not performing a commercially useful function.

(D) Joint Venture

When a MBE or WBE performs as a participant in a joint venture, the Contractor may count toward its contract goal requirement a portion of the total value of participation with the MBE or WBE in the joint venture, that portion of the total dollar value being a distinct clearly defined portion of work that the MBE or WBE performs with its forces.

(E) Manufacturer, Regular Dealer, Distributor

A Contractor may count toward its MBE/WBE requirement 40 percent of its expenditures for materials or supplies (including transportation costs) from a MBE/WBE distributor, 60 percent of its expenditures for materials or supplies (including transportation costs) from a MBE/WBE regular dealer and 100 percent of such expenditures obtained from a MBE/WBE manufacturer.

A Contractor may count toward its MBE/WBE requirement the following expenditures to MBE/WBE firms that are not manufacturers, regular dealers or distributors:

- (1) The fees or commissions charged by a MBE/WBE firm for providing a *bona fide* service, such as professional, technical, consultant, or managerial services, or for providing bonds or insurance specifically required for the performance of a DOT-assisted contract, provided the fees or commissions are determined to be reasonable and not excessive as compared with fees and commissions customarily allowed for similar services.
- (2) With respect to materials or supplies purchased from a MBE/WBE, which is neither a manufacturer, regular dealer, nor a distributor count the entire amount of fees or commissions charged that the Department deems to be reasonable, including transportation charges for the delivery of materials or supplies. Do not count any portion of the cost of the materials and supplies themselves.

A Contractor will submit a completed *DBE Regular Dealer/Distributor Affirmation Form* with the Letter of Intent to the Engineer. The Engineer will forward to the State Contractor Utilization Engineer or DBE@ncdot.gov. The State Contractor Utilization Engineer will make a preliminary assessment as to whether a MBE/WBE supplier has the demonstrated capacity to perform a commercially useful function (CUF) on a contract-by-contract basis *prior* to its participation.

Commercially Useful Function

(A) MBE/WBE Utilization

The Contractor may count toward its contract goal requirement only expenditures to MBEs and WBEs that perform a commercially useful function in the work of a contract. A MBE/WBE performs a commercially useful function when it is responsible for execution of the work of the contract and is carrying out its responsibilities by performing, managing, and supervising the work involved. To perform a commercially useful function, the MBE/WBE shall also be responsible with respect to materials and supplies used on the contract, for negotiating price, determining quality and quantity, ordering the material and installing (where applicable) and paying for the material itself. To determine whether a MBE/WBE is performing a commercially useful function, the Department will evaluate the amount of work subcontracted, industry practices, whether the amount the firm is to be paid under the contract is commensurate with the work it is performing and the MBE/WBE credit claimed for its performance of the work, and any other relevant factors. If it is determined that a MBE or WBE is not performing a Commercially Useful Function, the contractor may present evidence to rebut this presumption to the Department.

(B) MBE/WBE Utilization in Trucking

The following factors will be used to determine if a MBE or WBE trucking firm is performing a commercially useful function:

- (1) The MBE/WBE shall be responsible for the management and supervision of the entire trucking operation for which it is responsible on a particular contract, and there shall not be a contrived arrangement for the purpose of meeting the Combined MBE/WBE goal.
- (2) The MBE/WBE shall itself own and operate at least one fully licensed, insured, and operational truck used on the contract.
- (3) The MBE/WBE receives credit for the total value of the transportation services it provides on the contract using trucks it owns, insures, and operates using drivers it employs.
- (4) The MBE may subcontract the work to another MBE firm, including an owner-operator who is certified as a MBE. The same holds true that a WBE may subcontract the work to another WBE firm, including an owner-operator who is certified as a WBE. When this occurs, the MBE or WBE who subcontracts work receives credit for the total value of the transportation services the subcontracted MBE or WBE provides on the contract. It should be noted that every effort shall be made by MBE and WBE contractors to subcontract to the same certification (i.e., MBEs to MBEs and WBEs to WBEs), in order to fulfill the participation breakdown. This, however, may not always be possible due to the limitation of firms in the area. If the MBE or WBE firm shows a good faith effort has been made

to reach out to similarly certified transportation service providers and there is no interest or availability, and they can get assistance from other certified providers, the Engineer will not hold the prime responsible for meeting the individual MBE or WBE participation breakdown.

- (5) The MBE/WBE may also subcontract the work to a non-MBE/WBE firm, including from an owner-operator. The MBE/WBE who subcontracts the work to a non-MBE/WBE is entitled to credit for the total value of transportation services provided by the non-MBE/WBE subcontractor not to exceed the value of transportation services provided by MBE/WBE-owned trucks on the contract. Additional participation by non-MBE/WBE subcontractors receives credit only for the fee or commission it receives as a result of the subcontract arrangement. The value of services performed under subcontract agreements between the MBE/WBE and the Contractor will not count towards the MBE/WBE contract requirement.
- (6) A MBE/WBE may lease truck(s) from an established equipment leasing business open to the general public. The lease must indicate that the MBE/WBE has exclusive use of and control over the truck. This requirement does not preclude the leased truck from working for others during the term of the lease with the consent of the MBE/WBE, so long as the lease gives the MBE/WBE absolute priority for use of the leased truck. This type of lease may count toward the MBE/WBE's credit as long as the driver is under the MBE/WBE's payroll.
- (7) Subcontracted/leased trucks shall display clearly on the dashboard the name of the MBE/WBE that they are subcontracted/leased to and their own company name if it is not identified on the truck itself. Magnetic door signs are not permitted.

MBE/WBE Replacement

When a Contractor has relied on a commitment to a MBE or WBE subcontractor (or an approved substitute MBE or WBE subcontractor) to meet all or part of a contract goal requirement, the contractor shall not terminate the MBE/WBE subcontractor or any portion of its work for convenience. This includes, but is not limited to, instances in which the Contractor seeks to perform the work of the terminated subcontractor with another MBE/WBE subcontractor, a non-MBE/WBE subcontractor, or with the Contractor's own forces or those of an affiliate.

The Contractor must give notice in writing both by certified mail and email to the MBE/WBE subcontractor, with a copy to the Engineer of its intent to request to terminate a MBE/WBE subcontractor or any portion of its work, and the reason for the request. The Contractor must give the MBE/WBE subcontractor five (5) business days to respond to the Contractor's Notice of Intent to Request Termination and/or Substitution. If the MBE/WBE subcontractor objects to the intended termination/substitution, the MBE/WBE, within five (5) business days must advise the Contractor and the Department of the reasons why the action should not be approved. The five-day notice period shall begin on the next business day after written notice is provided to the MBE/WBE subcontractor.

A committed MBE/WBE subcontractor may only be terminated or any portion of its work after receiving the Department's written approval based upon a finding of good cause for the proposed termination and/or substitution. Good cause does not exist if the Contractor seeks to terminate a MBE/WBE or any portion of its work that it relied upon to obtain the contract so that the Contractor can self-perform the work for which the MBE/WBE was engaged, or so that the Contractor can substitute another MBE/WBE or non-MBE/WBE contractor after contract award. For purposes of this section, good cause shall include the following circumstances:

- (a) The listed MBE/WBE subcontractor fails or refuses to execute a written contract;
- (b) The listed MBE/WBE subcontractor fails or refuses to perform the work of its subcontract in a way consistent with normal industry standards. Provided, however, that good cause does not exist if the failure or refusal of the MBE/WBE subcontractor to perform its work on the subcontract results from the bad faith or discriminatory action of the prime contractor;
- (c) The listed MBE/WBE subcontractor fails or refuses to meet the prime contractor's reasonable, nondiscriminatory bond requirements;
- (d) The listed MBE/WBE subcontractor becomes bankrupt, insolvent, or exhibits credit unworthiness;

- (e) The listed MBE/WBE subcontractor is ineligible to work on public works projects because of suspension and debarment proceedings pursuant to 2 CFR parts 180, 215 and 1200 or applicable State law;
- (f) The listed MBE/WBE subcontractor is not a responsible contractor;
- (g) The listed MBE/WBE voluntarily withdraws from the project and provides written notice of withdrawal;
- (h) The listed MBE/WBE is ineligible to receive MBE/WBE credit for the type of work required;
- (i) A MBE/WBE owner dies or becomes disabled with the result that the listed MBE/WBE contractor is unable to complete its work on the contract; and
- (j) Other documented good cause that compels the termination of the MBE/WBE subcontractor.

The Contractor shall comply with the following for replacement of a committed MBE/WBE:

(A) Performance Related Replacement

When a committed MBE/WBE is terminated for good cause as stated above, an additional MBE/WBE that was submitted at the time of bid may be used to fulfill the MBE/WBE commitment to meet the Combined MBE/WBE Goal. A good faith effort will only be required for removing a committed MBE/WBE if there were no additional MBE/WBEs submitted at the time of bid to cover the same amount of work as the MBE/WBE that was terminated.

If a replacement MBE/WBE is not found that can perform at least the same amount of work as the terminated MBE/WBE, the Contractor shall submit a good faith effort documenting the steps taken. Such documentation shall include, but not be limited to, the following:

- (1) Copies of written notification to MBE/WBEs that their interest is solicited in contracting the work defaulted by the previous MBE/WBE or in subcontracting other items of work in the contract.
- (2) Efforts to negotiate with MBE/WBEs for specific subbids including, at a minimum:
 - (a) The names, addresses, and telephone numbers of MBE/WBEs who were contacted.
 - (b) A description of the information provided to MBE/WBEs regarding the plans and specifications for portions of the work to be performed.
- (3) A list of reasons why MBE/WBE quotes were not accepted.
- (4) Efforts made to assist the MBE/WBEs contacted, if needed, in obtaining bonding or insurance required by the Contractor.

(B) Decertification Replacement

- (1) When a committed MBE/WBE is decertified by the Department after the SAF (*Subcontract Approval Form*) has been received by the Department, the Department will not require the Contractor to solicit replacement MBE/WBE participation equal to the remaining work to be performed by the decertified firm. The participation equal to the remaining work performed by the decertified firm will count toward the contract goal requirement but not the overall goal.
 - (i) If the MBE/WBE's ineligibility is caused solely by its having exceeded the size standard during the performance of the contract. The Department may continue to count participation equal to the remaining work performed by the decertified firm which will count toward the contract goal requirement and overall goal.
 - (ii) If the MBE/WBE's ineligibility is caused solely by its acquisition by or merger with a non-MBE/WBE during the performance of the contract. The Department may not continue to count the portion of the decertified firm's performance on the contract remaining toward either the contract goal or the overall goal, even if the Contractor has executed a subcontract with the firm or the Department has executed a prime contract with the MBE/WBE that was later decertified.

- (2) When a committed MBE/WBE is decertified prior to the Department receiving the SAF (*Subcontract Approval Form*) for the named MBE/WBE firm, the Contractor shall take all necessary and reasonable steps to replace the MBE/WBE subcontractor with another MBE/WBE subcontractor to perform at least the same amount of work to meet the Combined MBE/WBE goal requirement. If a MBE/WBE firm is not found to do the same amount of work, a good faith effort must be submitted to NCDOT (see A herein for required documentation).

All requests for replacement of a committed MBE/WBE firm shall be submitted to the Engineer for approval on Form RF-1 (*DBE Replacement Request*). If the Contractor fails to follow this procedure, the Contractor may be disqualified from further bidding for a period of up to 6 months.

Changes in the Work

When the Engineer makes changes that result in the reduction or elimination of work to be performed by a committed MBE/WBE, the Contractor will not be required to seek additional participation. When the Engineer makes changes that result in additional work to be performed by a MBE/WBE based upon the Contractor's commitment, the MBE/WBE shall participate in additional work to the same extent as the MBE/WBE participated in the original contract work.

When the Engineer makes changes that result in extra work, which has more than a minimal impact on the contract amount, the Contractor shall seek additional participation by MBEs/WBEs unless otherwise approved by the Engineer.

When the Engineer makes changes that result in an alteration of plans or details of construction, and a portion or all of the work had been expected to be performed by a committed MBE/WBE, the Contractor shall seek participation by MBEs/WBEs unless otherwise approved by the Engineer.

When the Contractor requests changes in the work that result in the reduction or elimination of work that the Contractor committed to be performed by a MBE/WBE, the Contractor shall seek additional participation by MBEs/WBEs equal to the reduced MBE/WBE participation caused by the changes.

Reports and Documentation

A SAF (*Subcontract Approval Form*) shall be submitted for all work which is to be performed by a MBE/WBE subcontractor. The Department reserves the right to require copies of actual subcontract agreements involving MBE/WBE subcontractors.

When using transportation services to meet the contract commitment, the Contractor shall submit a proposed trucking plan in addition to the SAF. The plan shall be submitted prior to beginning construction on the project. The plan shall include the names of all trucking firms proposed for use, their certification type(s), the number of trucks owned by the firm, as well as the individual truck identification numbers, and the line item(s) being performed.

Within 30 calendar days of entering into an agreement with a MBE/WBE for materials, supplies or services, not otherwise documented by the SAF as specified above, the Contractor shall furnish the Engineer a copy of the agreement. The documentation shall also indicate the percentage (60% or 100%) of expenditures claimed for MBE/WBE credit.

Reporting Minority and Women Business Enterprise Participation

The Contractor shall provide the Engineer with an accounting of payments made to all MBE and WBE firms, including material suppliers and contractors at all levels (prime, subcontractor, or second tier subcontractor). This accounting shall be furnished to the Engineer for any given month by the end of the following month. Failure to submit this information accordingly may result in the following action:

- (A) Withholding of money due in the next partial pay estimate; or
- (B) Removal of an approved contractor from the prequalified bidders' list or the removal of other entities from the approved subcontractors list.

While each contractor (prime, subcontractor, 2nd tier subcontractor) is responsible for accurate accounting of payments to MBEs/WBEs, it shall be the prime contractor's responsibility to report all monthly and final payment information in the correct reporting manner.

Failure on the part of the Contractor to submit the required information in the time frame specified may result in the disqualification of that contractor and any affiliate companies from further bidding until the required information is submitted.

Failure on the part of any subcontractor to submit the required information in the time frame specified may result in the disqualification of that contractor and any affiliate companies from being approved for further work on future projects until the required information is submitted.

Contractors reporting transportation services provided by non-MBE/WBE lessees shall evaluate the value of services provided during the month of the reporting period only.

At any time, the Engineer can request written verification of subcontractor payments.

The Contractor shall report the accounting of payments through the Department's DBE Payment Tracking System.

Failure to Meet Contract Requirements

Failure to meet contract requirements in accordance with Subarticle 102-15(J) of the *Standard Specifications* may be cause to disqualify the Contractor.

STANDARD SPECIAL PROVISIONS

AVAILABILITY OF FUNDS – TERMINATION OF CONTRACTS

(5-20-08)(Rev. 1-16-24)

Z-2

General Statute 143C-6-11. (h) Highway Appropriation is hereby incorporated verbatim in this contract as follows:

(h) Amounts Encumbered. – Transportation project appropriations may be encumbered in the amount of allotments made to the Department of Transportation by the Director for the estimated payments for transportation project contract work to be performed in the appropriation fiscal year. The allotments shall be multiyear allotments and shall be based on estimated revenues and shall be subject to the maximum contract authority contained in *General Statute 143C-6-11(c)*. Payment for transportation project work performed pursuant to contract in any fiscal year other than the current fiscal year is subject to appropriations by the General Assembly. Transportation project contracts shall contain a schedule of estimated completion progress, and any acceleration of this progress shall be subject to the approval of the Department of Transportation provided funds are available. The State reserves the right to terminate or suspend any transportation project contract, and any transportation project contract shall be so terminated or suspended if funds will not be available for payment of the work to be performed during that fiscal year pursuant to the contract. In the event of termination of any contract, the contractor shall be given a written notice of termination at least 60 days before completion of scheduled work for which funds are available. In the event of termination, the contractor shall be paid for the work already performed in accordance with the contract specifications.

Payment will be made on any contract terminated pursuant to the special provision in accordance with Subarticle 108-13(D) of the *Standard Specifications*.

AUTHORITY OF THE ENGINEER

The Engineer for this project shall be the Division Engineer (NCDOT Division of Highways) for the Division in which the project is located, acting directly or through their duly authorized representatives, typically the Division Roadside Environmental Engineer.

The Engineer will decide on all questions regarding the quality and acceptability of work performed, rate of work progress, interpretation of the contract, and acceptable fulfillment of the contract by the Contractor. The Engineer shall have the authority to alter mowing priorities in order to address special needs of the Department. The Engineer's decision shall be final, and they shall have executive authority to enforce and make effective such decisions and orders the Contractor fails to carry out promptly.

MINIMUM WAGES

FEDERAL

The Fair Labor Standards Act provides that with certain exceptions, every employer must pay wages at the current rate of not less than seven dollars and twenty five cents per hour (\$7.25 / HR).

STATE

The North Carolina Minimum Wage Act provides that with certain exceptions, every employer must pay wages at the current rate of not less than seven dollars and twenty five cents per hour (\$7.25 / HR).

The minimum wage paid to all skilled labor employed on this contract shall be not less than seven dollars and twenty five cents per hour (\$7.25 / HR).

The minimum wage paid to all intermediate labor employed on this contract shall be not less than seven dollars and twenty five cents per hour (\$7.25 / HR).

The minimum wage paid to all unskilled labor on this contract shall be not less than seven dollars and twenty five cents per hour (\$7.25 / HR).

This determination of the intent of the application of this Act to the contract on this project is the responsibility of the Contractor. However, the Contractor shall be required to provide certified payrolls upon written request of the Engineer.

The Contractor shall have no claim against the Department of Transportation for any changes in the minimum wage laws, State or Federal. It is the responsibility of the Contractor to keep fully informed of all Federal and State laws affecting the contract.

RIGHT OF THE CONTRACTOR TO FILE CLAIM

If a dispute arises over payment under the terms of this contract, the Contractor shall notify the Department in writing of intent to file a claim. Such notice shall be given in writing within 30 days of the end of the month in which the dispute arose.

If notice of intent has been given, the Contractor may submit a written claim for such amounts to which they deem themselves entitled. The claim shall be submitted in writing to the Division Engineer within 30 days of the end of the annual contract period.

If the Contractor fails to receive such settlement per their claim, they may submit a written and verified claim to the Chief Engineer. The written and verified claim shall be submitted within 60 days from the time the Contractor receives notice of findings from the Division Engineer.

The provisions of N.C.G.S. § 136-29 shall apply to this contract.

DEFAULT OF CONTRACT

The Department shall have the right to declare a default of contract for breach by the Contractor of any material term or condition of the contract as determined by the Department. Material breach by the Contractor shall include, but specifically shall not be limited to failure to begin work under the contract within the time specified; failure to provide workmen, equipment, or materials adequate to perform the work in conformity with the contract by the completion date; unsatisfactory performance of the work, refusal or failure to replace defective work; failure to maintain satisfactory work progress; failure to comply with equal employment opportunity contract requirements; insolvency or bankruptcy, or any act of insolvency or bankruptcy; failure to satisfy any final judgment within 10 calendar days after entry thereof; and making an assignment for benefit of creditors. Refer to Section 108-9 in the “*Standard Specifications for Roads and Structures*” for additional information.

SUBLETTING OF CONTRACT

If a Contractor desires to sublet any work, written consent must be given by the Engineer. The approval of any subcontract will not release the Contractor of liability under the contract, nor will the subcontractor or the second tier subcontractor have any claim against NCDOT by reason of the approval of the subcontract.

SAFETY AND ACCIDENT PROTECTION

The Contractor shall comply with all applicable Federal, State, and local laws, ordinances, and regulations governing safety, health, and sanitation; and shall provide all safeguards, safety devices, and protective equipment. The Contractor shall take any other needed actions that are reasonably necessary to protect the life and health of employees on the job and the safety of the public, and to protect property in connection with the performance of the work covered by the contract.

UTILITY CONFLICTS

Special care shall be used in working around or near existing utilities, protecting them when necessary to provide uninterrupted service. In the event that any utility service is interrupted, the Contractor shall notify the utility owner immediately and shall cooperate with the owner, or their representative, in the restoration of service in the shortest time possible. Existing fire hydrants shall be kept accessible to fire departments at all times.

The Contractor shall adhere to all applicable regulations, and follow accepted safety procedures when working in the vicinity of utilities in order to ensure the safety of working personnel and the public.

DRIVEWAYS AND PRIVATE PROPERTY

The Contractor shall maintain access to driveways for all residents and property owners throughout the life of the project. The Contractor shall not perform work for private citizens or agencies in conjunction with this project or within the project limits of this contract.

COOPERATION BETWEEN CONTRACTORS

The Department reserves the right at any time to contract for and perform other or additional work on or near the work covered by the contract. When separate or additional contracts are let within the limits of any one project, each Contractor shall conduct his work so as not to interfere with or hinder the progress or completion of the work being performed by other Contractors. Contractors working within the limits of the same project shall cooperate with each other. Each Contractor shall conduct his operations in such a manner as to avoid damaging any work being performed by others or which others have completed.

COOPERATION WITH STATE FORCES

The Contractor must cooperate with State forces working within the limits of this project as directed by the Engineer.

POSTED WEIGHT LIMITS

The Contractor's attention is directed to Article 105-15 of the *Standard Specifications* and to the fact that various Primary and Secondary Roads and bridges may be posted with weight limits less than the legal limit. Do not exceed the posted weight limits in transporting materials and/or equipment to the projects. Make a thorough examination of all projects and haul routes and be prepared to discuss them at the Preconstruction Conference.

NO MAJOR CONTRACT ITEMS

None of the items included in this contract will be major items.

NO SPECIALTY ITEMS

(7-1-95)(Rev. 1-16-24)

108-6

SP1 G34

None of the items included in this contract will be specialty items (see Article 108-6 of the *Standard Specifications*).

SUBSURFACE INFORMATION

There is **no** subsurface information available on this project. The Contractor shall make his own investigation of subsurface conditions.

RESTRICTIONS ON ITS EQUIPMENT AND SERVICES

(11-17-20)

SP01 G090

All telecommunications, video or other ITS equipment or services installed or utilized on this project must be in conformance with UNIFORM ADMINISTRATIVE REQUIREMENTS, COST PRINCIPLES, AND AUDIT REQUIREMENTS FOR FEDERAL AWARDS 2 CFR, § 200.216 **Prohibition on certain telecommunications and video surveillance services or equipment.**

USE OF UNMANNED AIRCRAFT SYSTEM (UAS)

(8-20-19)

SP01 G092

The Contractor shall adhere to all Federal, State and Local regulations and guidelines for the use of Unmanned Aircraft Systems (UAS). This includes but is not limited to US 14 CFR Part 107 *Small UAS Rule*, NC GS 15A-300.2 *Regulation of launch and recovery sites*, NC GS 63-95 *Training required for the operation of unmanned aircraft systems*, NC GS 63-96 *Permit required for commercial operation of unmanned aircraft system*, and NCDOT UAS Policy. The required operator certifications include possessing a current Federal Aviation Administration (FAA) Remote Pilot Certificate, a NC UAS Operator Permit as well as operating a UAS registered with the FAA.

Prior to beginning operations, the Contractor shall complete the NCDOT UAS – Flight Operation Approval Form and submit it to the Engineer for approval. All UAS operations shall be approved by the Engineer prior to beginning the operations.

All contractors or subcontractors operating UAS shall have UAS specific general liability insurance to cover all operations under this contract.

The use of UAS is at the Contractor's discretion. No measurement or payment will be made for the use of UAS. In the event that the Department directs the Contractor to utilize UAS, payment will be in accordance with Article 104-7 Extra Work.

OUTSOURCING OUTSIDE OF THE USA

All work on consultant contracts, services contracts, and construction contracts shall be performed in the United States of America. No work shall be outsourced outside of the United States of America.

Outsourcing for the purpose of this provision is defined as the practice of subcontracting labor, work, services, staffing, or personnel to entities located outside of the United States.

The North Carolina Secretary of Transportation shall approve exceptions to this provision in writing.

TITLE VI AND NONDISCRIMINATION

(6-28-77)(Rev 1/16/2024)

Z-6

The North Carolina Department of Transportation is committed to carrying out the U.S. Department of Transportation's policy of ensuring nondiscrimination in the award and administration of contracts.

The provisions of this section related to United States Department of Transportation (US DOT) Order 1050.2A, Title 49 Code of Federal Regulations (CFR) part 21, 23 United States Code (U.S.C.) 140 and 23 CFR part 200 (or 49 CFR 303, 49 U.S.C. 5332 or 49 U.S.C. 47123) are applicable to all North Carolina Department of Transportation (NCDOT) contracts and to all related subcontracts, material supply, engineering, architectural and other service contracts, regardless of dollar amount. Any Federal provision that is specifically required not specifically set forth is hereby incorporated by reference.

(1) Title VI Assurances (USDOT Order 1050.2A, Appendix A)

During the performance of this contract, the contractor, for itself, its assignees, and successors in interest (hereinafter referred to as the "contractor") agrees as follows:

(a) Compliance with Regulations

The contractor (hereinafter includes consultants) shall comply with the Acts and the Regulations relative to Nondiscrimination in Federally-assisted programs of the U.S. Department of Transportation, Federal Highway Administration (FHWA), as they may be amended from time to time, which are herein incorporated by reference and made a part of this contract.

(b) Nondiscrimination

The contractor, with regard to the work performed by it during the contract, shall not discriminate on the grounds of race, color, or national origin in the selection and retention of subcontractors, including procurements of materials and

leases of equipment. The contractor shall not participate directly or indirectly in the discrimination prohibited by the Acts and the Regulations, including employment practices when the contract covers any activity, project, or program set forth in Appendix B of 49 CFR Part 21.

(c) Solicitations for Subcontractors, Including Procurements of Materials and Equipment

In all solicitations, either by competitive bidding, or negotiation made by the contractor for work to be performed under a subcontract, including procurements of materials, or leases of equipment, each potential subcontractor or supplier shall be notified by the contractor of the contractor's obligations under this contract and the Acts and the Regulations relative to Nondiscrimination on the grounds of race, color, or national origin.

(d) Information and Reports

The contractor shall provide all information and reports required by the Acts, the Regulations, and directives issued pursuant thereto and shall permit access to its books, records, accounts, other sources of information, and its facilities as may be determined by the Recipient or the FHWA to be pertinent to ascertain compliance with such Acts, Regulations, and instructions. Where any information required of a contractor is in the exclusive possession of another who fails or refuses to furnish the information, the contractor shall so certify to the Recipient or the FHWA, as appropriate, and shall set forth what efforts it has made to obtain the information.

(e) Sanctions for Noncompliance:

In the event of a contractor's noncompliance with the Non-discrimination provisions of this contract, the Recipient will impose such contract sanctions as it and/or the FHWA may determine to be appropriate, including, but not limited to:

- (i) Withholding payments to the contractor under the contract until the contractor complies; and/or
- (ii) Cancelling, terminating, or suspending a contract, in whole or in part.

(f) Incorporation of Provisions

The contractor shall include the provisions of paragraphs (a) through (f) in every subcontract, including procurements of materials and leases of equipment, unless exempt by the Acts, the Regulations and directives issued pursuant thereto. The contractor shall take action with respect to any subcontract or procurement as the Recipient or the FHWA may direct as a means of enforcing such provisions including sanctions for noncompliance. Provided, that if the contractor becomes involved in, or is threatened with litigation by a subcontractor, or supplier because of such direction, the contractor may request the Recipient to enter into any litigation to protect the interests of the Recipient. In addition, the contractor may request the United States to enter into the litigation to protect the interests of the United States.

(2) Title VI Nondiscrimination Program (23 CFR 200.5(p))

The North Carolina Department of Transportation (NCDOT) has assured the USDOT that, as a condition to receiving federal financial assistance, NCDOT will comply with Title VI of the Civil Rights Act of 1964 and all requirements imposed by Title 49 CFR part 21 and related nondiscrimination authorities to ensure that no person shall, on the ground of race, color, national origin, limited English proficiency, sex, age, or disability (including religion/creed or income-level, where applicable), be excluded from participation in, be denied the benefits of, or be subjected to discrimination under any programs, activities, or services conducted or funded by NCDOT. Contractors and other organizations under contract or agreement with NCDOT must also comply with Title VI and related authorities, therefore:

- (a) During the performance of this contract or agreement, contractors (e.g., subcontractors, consultants, vendors, prime contractors) are responsible for complying with NCDOT's Title VI Program. Contractors are not required to prepare or submit Title VI Programs. To comply with this section, the prime contractor shall:
 1. Post NCDOT's Notice of Nondiscrimination and the Contractor's own Equal Employment Opportunity (EEO) Policy in conspicuous locations accessible to all employees, applicants and subcontractors on the jobsite.
 2. Physically incorporate the required Title VI clauses into all subcontracts on federally-assisted and state-funded NCDOT projects, and ensure inclusion by subcontractors into all lower-tier subcontracts.
 3. Required Solicitation Language. The Contractor shall include the following notification in all solicitations for bids and requests for work or material, regardless of funding source:

“The North Carolina Department of Transportation, in accordance with the provisions of Title VI of the Civil Rights Act of 1964 (78 Stat. 252, 42 U.S.C. §§ 2000d to 2000d-4) and the Regulations, hereby notifies all bidders that it will affirmatively ensure that any contract entered into pursuant to this advertisement, disadvantaged business enterprises will be afforded full and fair opportunity to submit bids in response to this invitation and will not be discriminated against on the grounds of race, color, or national origin in consideration for an award. In accordance with other related nondiscrimination authorities, bidders and contractors will also not be discriminated against on the grounds of sex, age, disability, low-income level, creed/religion, or limited English proficiency in consideration for an award.”

4. Physically incorporate the FHWA-1273, in its entirety, into all subcontracts and subsequent lower tier subcontracts on Federal-aid highway construction contracts only.
 5. Provide language assistance services (i.e., written translation and oral interpretation), free of charge, to LEP employees and applicants. Contact NCDOT OCR for further assistance, if needed.
 6. For assistance with these Title VI requirements, contact the NCDOT Title VI Nondiscrimination Program at 1-800-522-0453.
- (b) Subrecipients (e.g. cities, counties, LGAs, planning organizations) may be required to prepare and submit a Title VI Plan to NCDOT, including Title VI Assurances and/or agreements. Subrecipients must also ensure compliance by their contractors and subrecipients with Title VI. (23 CFR 200.9(b)(7))
- (c) If reviewed or investigated by NCDOT, the contractor or subrecipient agrees to take affirmative action to correct any deficiencies found within a reasonable time period, not to exceed 90 calendar days, unless additional time is granted by NCDOT. (23 CFR 200.9(b)(15))
- (d) The Contractor is responsible for notifying subcontractors of NCDOT’s External Discrimination Complaints Process.

1. Applicability

Title VI and related laws protect participants and beneficiaries (e.g., members of the public and contractors) from discrimination by NCDOT employees, subrecipients and contractors, regardless of funding source.

2. Eligibility

Any person—or class of persons—who believes he/she has been subjected to discrimination based on race, color, national origin, Limited English Proficiency (LEP), sex, age, or disability (and religion in the context of employment, aviation, or transit) may file a written complaint. The law also prohibits intimidation or retaliation of any sort.

3. Time Limits and Filing Options

Complaints may be filed by the affected individual(s) or a representative and must be filed no later than 180 calendar days after the following:

- (i) The date of the alleged act of discrimination; or
- (ii) The date when the person(s) became aware of the alleged discrimination; or
- (iii) Where there has been a continuing course of conduct, the date on which that conduct was discontinued or the latest instance of the conduct.

Title VI and related discrimination complaints may be submitted to the following entities:

- North Carolina Department of Transportation, Office of Civil Rights, Title VI Program, 1511 Mail Service Center, Raleigh, NC 27699-1511; toll free 1-800-522-0453
- Federal Highway Administration, North Carolina Division Office, 310 New Bern Avenue, Suite 410, Raleigh, NC 27601, 919-747-7010
- US Department of Transportation, Departmental Office of Civil Rights, External Civil Rights Programs Division, 1200 New Jersey Avenue, SE, Washington, DC 20590; 202-366-4070

4. Format for Complaints

Complaints must be in writing and signed by the complainant(s) or a representative, and include the complainant's name, address, and telephone number. Complaints received by fax or e-mail will be acknowledged and processed. Allegations received by telephone will be reduced to writing and provided to the complainant for confirmation or revision before processing. Complaints will be accepted in other languages, including Braille.

5. Discrimination Complaint Form

Contact NCDOT Civil Rights to receive a full copy of the Discrimination Complaint Form and procedures.

6. Complaint Basis

Allegations must be based on issues involving race, color, national origin (LEP), sex, age, disability, or religion (in the context of employment, aviation or transit). "Basis" refers to the complainant's membership in a protected group category.

TABLE 103-1 COMPLAINT BASIS			
Protected Categories	Definition	Examples	Applicable Nondiscrimination Authorities
Race and Ethnicity	An individual belonging to one of the accepted racial groups; or the perception, based usually on physical characteristics that a person is a member of a racial group	Black/African American, Hispanic/Latino, Asian, American Indian/Alaska Native, Native Hawaiian/Pacific Islander, White	Title VI of the Civil Rights Act of 1964; 49 CFR Part 21; 23 CFR 200; 49 U.S.C. 5332(b); 49 U.S.C. 47123. <i>(Executive Order 13166)</i>
Color	Color of skin, including shade of skin within a racial group	Black, White, brown, yellow, etc.	
National Origin (<i>Limited English Proficiency</i>)	Place of birth. Citizenship is not a factor. (<i>Discrimination based on language or a person's accent is also covered</i>)	Mexican, Cuban, Japanese, Vietnamese, Chinese	
Sex	Gender. The sex of an individual. <i>Note: Sex under this program does not include sexual orientation.</i>	Women and Men	1973 Federal-Aid Highway Act; 49 U.S.C. 5332(b); 49 U.S.C. 47123.
Age	Persons of any age	21-year-old person	Age Discrimination Act of 1975 49 U.S.C. 5332(b); 49 U.S.C. 47123.
Disability	Physical or mental impairment, permanent or temporary, or perceived.	Blind, alcoholic, para-amputee, epileptic, diabetic, arthritic	Section 504 of the Rehabilitation Act of 1973; Americans with Disabilities Act of 1990

<p>Religion (in the context of employment)</p> <p><i>(Religion/ Creed in all aspects of any aviation or transit-related construction)</i></p>	<p>An individual belonging to a religious group; or the perception, based on distinguishable characteristics that a person is a member of a religious group. In practice, actions taken as a result of the moral and ethical beliefs as to what is right and wrong, which are sincerely held with the strength of traditional religious views. Note: Does not have to be associated with a recognized religious group or church; if an individual sincerely holds to the belief, it is a protected religious practice.</p>	<p>Muslim, Christian, Sikh, Hindu, etc.</p>	<p>Title VII of the Civil Rights Act of 1964; 23 CFR 230; FHWA-1273 Required Contract Provisions. <i>(49 U.S.C. 5332(b); 49 U.S.C. 47123)</i></p>
---	---	---	---

(3) Pertinent Nondiscrimination Authorities

During the performance of this contract, the contractor, for itself, its assignees, and successors in interest agrees to comply with the following non-discrimination statutes and authorities, including, but not limited to:

- Title VI of the Civil Rights Act of 1964 (42 U.S.C. § 2000d et seq., 78 stat. 252), (prohibits discrimination on the basis of race, color, national origin); and 49 CFR Part 21.
- The Uniform Relocation Assistance and Real Property Acquisition Policies Act of 1970, (42 U.S.C. § 4601), (prohibits unfair treatment of persons displaced or whose property has been acquired because of Federal or Federal-aid programs and projects);
- Federal-Aid Highway Act of 1973, (23 U.S.C. § 324 et seq.), (prohibits discrimination on the basis of sex);
- Section 504 of the Rehabilitation Act of 1973, (29 U.S.C. § 794 et seq.), as amended, (prohibits discrimination on the basis of disability) and 49 CFR Part 27;
- The Age Discrimination Act of 1975, as amended, (42 U.S.C. § 6101 et seq.), (prohibits discrimination on the basis of age);
- Airport and Airway Improvement Act of 1982, (49 USC § 471, Section 47123), as amended, (prohibits discrimination based on race, creed, color, national origin, or sex);
- (g) The Civil Rights Restoration Act of 1987, (PL 100-209), (Broadened the scope, coverage and applicability of Title VI of the Civil Rights Act of 1964, The Age Discrimination Act of 1975 and Section 504 of the Rehabilitation Act of 1973, by expanding the definition of the terms "programs or activities" to include all of the programs or activities of the Federal-aid recipients, sub-recipients and contractors, whether such programs or activities are Federally funded or not);
- (h) Titles II and III of the Americans with Disabilities Act, which prohibit discrimination on the basis of disability in the operation of public entities, public and private transportation systems, places of public accommodation, and certain testing entities (42 U.S.C. §§ 12131-12189) as implemented by Department of Transportation regulations at 49 C.F.R. parts 37 and 38;
- (i) The Federal Aviation Administration's Nondiscrimination statute (49 U.S.C. § 47123) (prohibits discrimination on the basis of race, color, national origin, and sex);
- (j) Executive Order 12898, Federal Actions to Address Environmental Justice in Minority Populations and Low-Income Populations, which ensures Nondiscrimination against minority populations by discouraging programs, policies, and activities with disproportionately high and adverse human health or environmental effects on minority and low-income populations;
- (k) Executive Order 13166, Improving Access to Services for Persons with Limited English Proficiency, and resulting agency guidance, national origin discrimination includes discrimination because of Limited English proficiency (LEP).

To ensure compliance with Title VI, you must take reasonable steps to ensure that LEP persons have meaningful access to your programs (70 Fed. Reg. at 74087 to 74100);

- (l) Title IX of the Education Amendments of 1972, as amended, which prohibits you from discriminating because of sex in education programs or activities (20 U.S.C. 1681 et seq).
- (m) Title VII of the Civil Rights Act of 1964 (42 U.S.C. § 2000e et seq., Pub. L. 88-352), (prohibits employment discrimination on the basis of race, color, religion, sex, or national origin).

(4) Additional Title VI Assurances

***The following Title VI Assurances (Appendices B, C and D) shall apply, as applicable*

(a) Clauses for Deeds Transferring United States Property (1050.2A, Appendix B)

The following clauses will be included in deeds effecting or recording the transfer of real property, structures, or improvements thereon, or granting interest therein from the United States pursuant to the provisions of Assurance 4.

NOW, THEREFORE, the U.S. Department of Transportation as authorized by law and upon the condition that the North Carolina Department of Transportation (NCDOT) will accept title to the lands and maintain the project constructed thereon in accordance with the North Carolina General Assembly, the Regulations for the Administration of the Federal-Aid Highway Program, and the policies and procedures prescribed by the Federal Highway Administration of the U.S. Department of Transportation in accordance and in compliance with all requirements imposed by Title 49, Code of Federal Regulations, U.S. Department of Transportation, Subtitle A, Office of the Secretary, Part 21, Nondiscrimination in Federally-assisted programs of the U.S Department of Transportation pertaining to and effectuating the provisions of Title VI of the Civil Rights Act of 1964 (78 Stat. 252; 42 U.S.C. § 2000d to 2000d-4), does hereby remise, release, quitclaim and convey unto the NCDOT all the right, title and interest of the U.S. Department of Transportation in and to said lands described in Exhibit A attached hereto and made a part hereof.

(HABENDUM CLAUSE)

TO HAVE AND TO HOLD said lands and interests therein unto the North Carolina Department of Transportation (NCDOT) and its successors forever, subject, however, to the covenants, conditions, restrictions and reservations herein contained as follows, which will remain in effect for the period during which the real property or structures are used for a purpose for which Federal financial assistance is extended or for another purpose involving the provision of similar services or benefits and will be binding on the NCDOT, its successors and assigns.

The NCDOT, in consideration of the conveyance of said lands and interests in lands, does hereby covenant and agree as a covenant running with the land for itself, its successors and assigns, that (1) no person will on the grounds of race, color, or national origin, be excluded from participation in, be denied the benefits of, or be otherwise subjected to discrimination with regard to any facility located wholly or in part on, over, or under such lands hereby conveyed [,] [and]* (2) that the NCDOT will use the lands and interests in lands and interests in lands so conveyed, in compliance with all requirements imposed by or pursuant to Title 49, Code of Federal Regulations, U.S. Department of Transportation, Subtitle A, Office of the Secretary, Part 21, Non-discrimination in Federally-assisted programs of the U.S. Department of Transportation, Effectuation of Title VI of the Civil Rights Act of 1964, and as said Regulations and Acts may be amended [, and (3) that in the event of breach of any of the above-mentioned nondiscrimination conditions, the Department will have a right to enter or re-enter said lands and facilities on said land, and that above described land and facilities will thereon revert to and vest in and become the absolute property of the U.S. Department of Transportation and its assigns as such interest existed prior to this instruction].*

(*Reverter clause and related language to be used only when it is determined that such a clause is necessary in order to make clear the purpose of Title VI.)

(b) Clauses for Transfer of Real Property Acquired or Improved Under the Activity, Facility, or Program (1050.2A, Appendix C)

The following clauses will be included in deeds, licenses, leases, permits, or similar instruments entered into by the North Carolina Department of Transportation (NCDOT) pursuant to the provisions of Assurance 7(a):

1. The (grantee, lessee, permittee, etc. as appropriate) for himself/herself, his/her heirs, personal representatives, successors in interest, and assigns, as a part of the consideration hereof, does hereby covenant and agree [in the case of deeds and leases add "as a covenant running with the land"] that:
 - (i.) In the event facilities are constructed, maintained, or otherwise operated on the property described in this (deed, license, lease, permit, etc.) for a purpose for which a U.S. Department of Transportation activity, facility, or program is extended or for another purpose involving the provision of similar services or benefits, the (grantee, licensee, lessee, permittee, etc.) will maintain and operate such facilities and services in compliance with all requirements imposed by the Acts and Regulations (as may be amended) such that no person on the grounds of race, color, or national origin, will be excluded from participation in, denied the benefits of, or be otherwise subjected to discrimination in the use of said facilities.
2. With respect to licenses, leases, permits, etc., in the event of breach of any of the above Nondiscrimination covenants, the NCDOT will have the right to terminate the (lease, license, permit, etc.) and to enter, re-enter, and repossess said lands and facilities thereon, and hold the same as if the (lease, license, permit, etc.) had never been made or issued. *
3. With respect to a deed, in the event of breach of any of the above Nondiscrimination covenants, the NCDOT will have the right to enter or re-enter the lands and facilities thereon, and the above described lands and facilities will there upon revert to and vest in and become the absolute property of the NCDOT and its assigns. *

(*Reverter clause and related language to be used only when it is determined that such a clause is necessary to make clear the purpose of Title VI.)

- (c) Clauses for Construction/Use/Access to Real Property Acquired Under the Activity, Facility or Program (1050.2A, Appendix D)

The following clauses will be included in deeds, licenses, permits, or similar instruments/ agreements entered into by the North Carolina Department of Transportation (NCDOT) pursuant to the provisions of Assurance 7(b):

1. The (grantee, licensee, permittee, etc., as appropriate) for himself/herself, his/her heirs, personal representatives, successors in interest, and assigns, as a part of the consideration hereof, does hereby covenant and agree (in the case of deeds and leases add, "as a covenant running with the land") that (1) no person on the ground of race, color, or national origin, will be excluded from participation in, denied the benefits of, or be otherwise subjected to discrimination in the use of said facilities, (2) that in the construction of any improvements on, over, or under such land, and the furnishing of services thereon, no person on the ground of race, color, or national origin, will be excluded from participation in, denied the benefits of, or otherwise be subjected to discrimination, (3) that the (grantee, licensee, lessee, permittee, etc.) will use the premises in compliance with all other requirements imposed by or pursuant to the Acts and Regulations, as amended, set forth in this Assurance.
2. With respect to (licenses, leases, permits, etc.), in the event of breach of any of the above Non- discrimination covenants, the NCDOT will have the right to terminate the (license, permit, etc., as appropriate) and to enter or re-enter and repossess said land and the facilities thereon, and hold the same as if said (license, permit, etc., as appropriate) had never been made or issued. *
3. With respect to deeds, in the event of breach of any of the above Nondiscrimination covenants, the NCDOT will there upon revert to and vest in and become the absolute property of the NCDOT and its assigns. *

(*Reverter clause and related language to be used only when it is determined that such a clause is necessary to make clear the purpose of Title VI.)

APPENDIX

Note: The following drawings may be identified as “ditch” or “swath”. Refer to the Project Special Provisions to identify which drawings will pertain to a contract awarded pursuant to this RFP.

TYPICAL SECTIONS

TYPICAL MULTI-LANE HIGHWAY

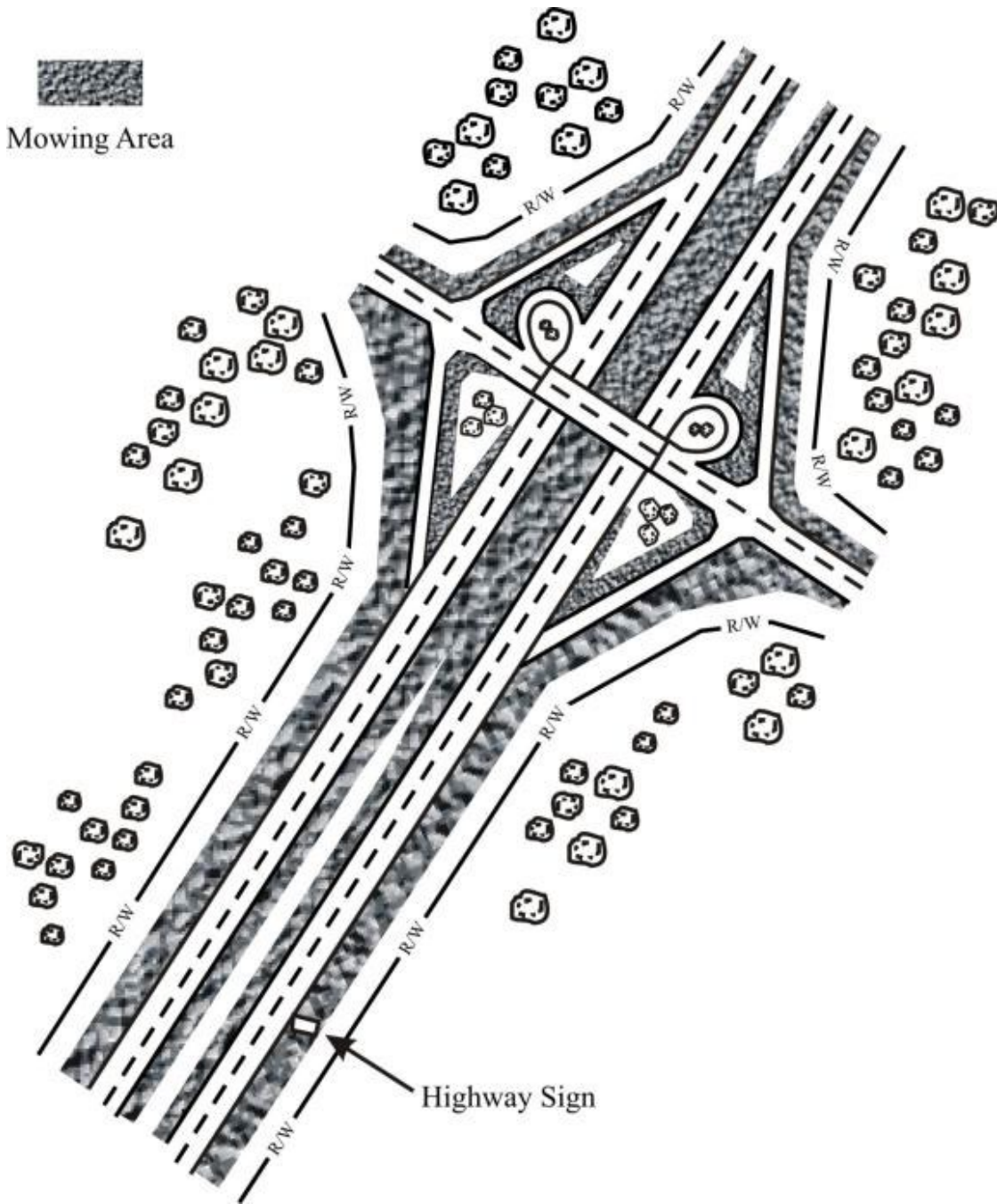

Note: On divided highways, mowing in the median shall be performed in accordance with the established mowing patterns.

TYPICAL FOUR LANE HIGHWAY SECTION SPREAD MEDIAN

For Swath Contracts:

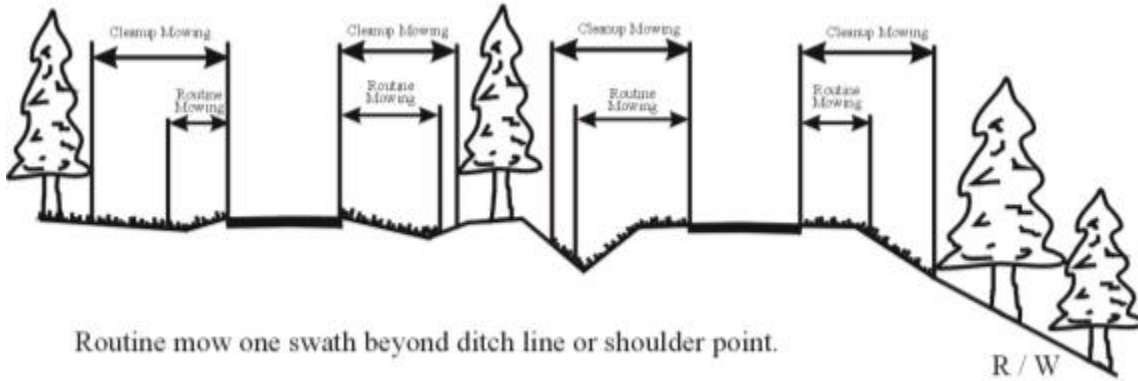

Routine mow one swath beyond ditch line or shoulder point.

Cleanup mow to R/W or mowing pattern.

For Ditch Contracts:

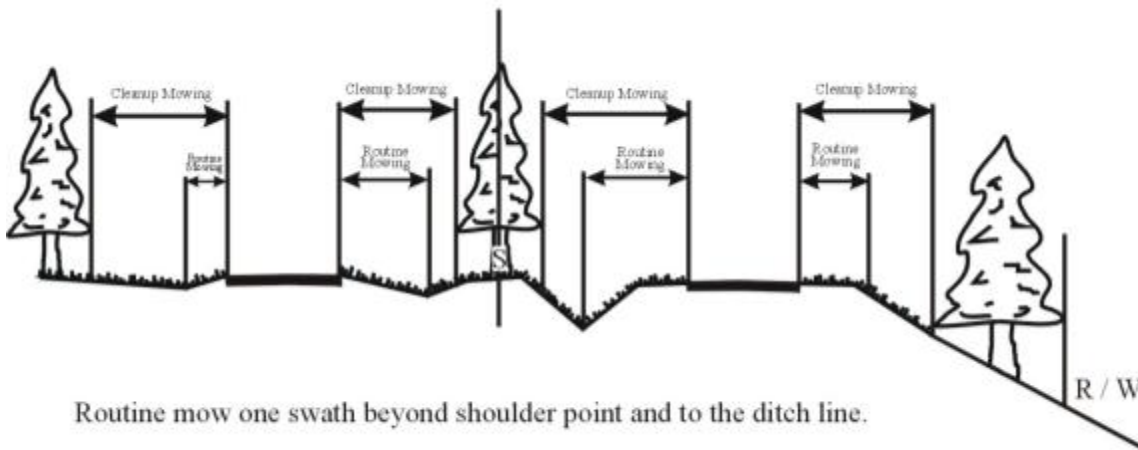

Routine mow one swath beyond shoulder point and to the ditch line.

Cleanup mow to R/W or mowing pattern.

TYPICAL FOUR LANE HIGHWAY SECTION NARROW MEDIAN

For Swath Contracts:

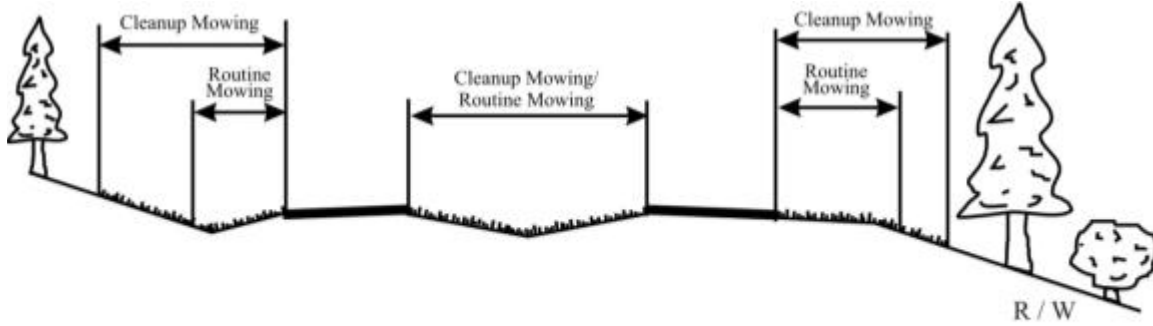

Routine mow one swath beyond ditch line or shoulder point.

Cleanup mow to R/W or mowing pattern.

For Ditch Contracts:

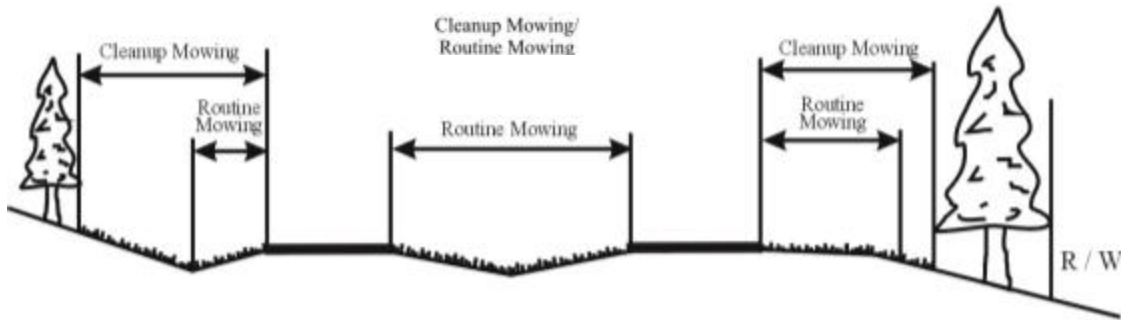

Routine mow one swath beyond shoulder point and to the ditch line.

Cleanup mow to R/W or mowing pattern.

TYPICAL TWO LANE HIGHWAY

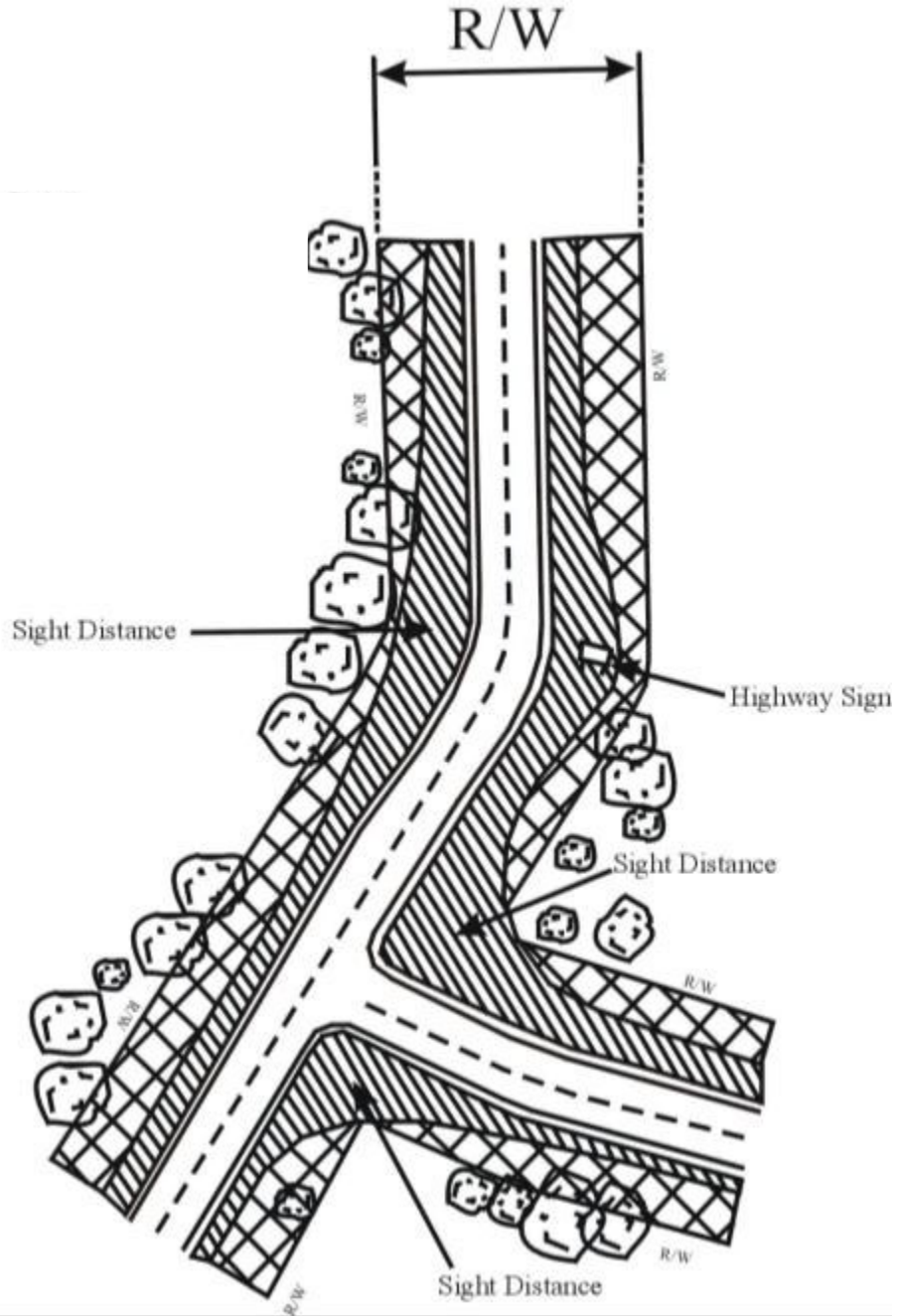

TYPICAL CUT SECTION WITH SLOPE FLATTER THAN 2:1

For Swath Contracts:

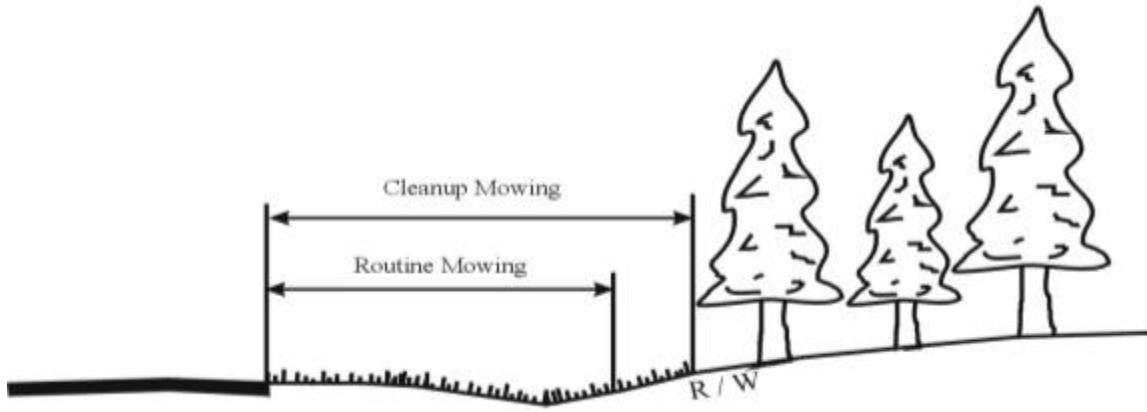

TYPICAL CUT SECTION WITH SLOPE FLATTER THAN 2:1

Routine mowing to one swath beyond ditch line.

Cleanup mow to established mowing pattern line or R/W.

For Ditch Contracts:

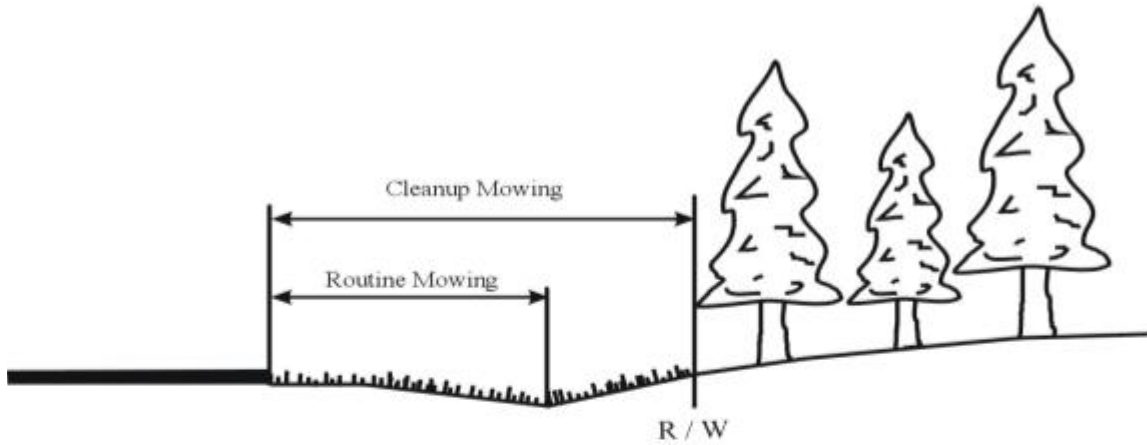

TYPICAL CUT SECTION WITH SLOPE FLATTER THAN 2:1

Routine mowing to ditch line.

Cleanup mow to established mowing pattern line or R/W.

TYPICAL CUT SECTION WITH SLOPE 2:1 AND STEEPER
For Swath Contracts:

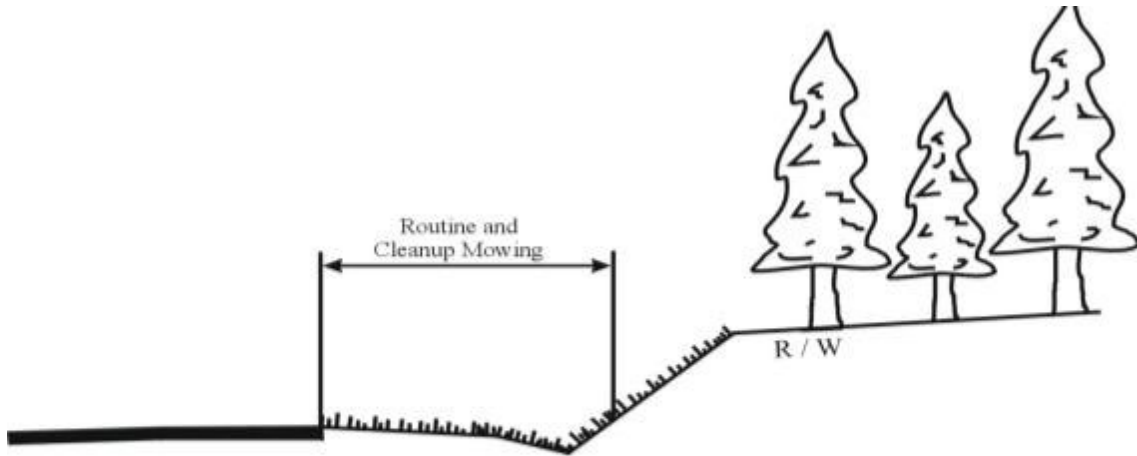

TYPICAL CUT SECTION WITH SLOPE 2:1 AND STEEPER.
Routine and cleanup mowing to ditch line and one swath onto cut slope.

For Ditch Contracts:

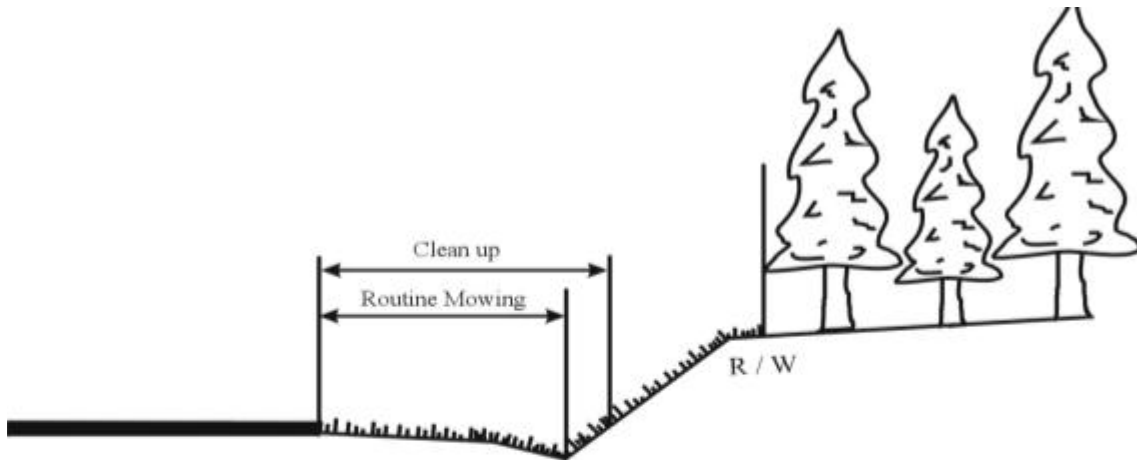

TYPICAL CUT SECTION WITH SLOPE 2:1 AND STEEPER.
Routine mowing to ditch line.
Clean up mowing one swath up cut slope.

TYPICAL FILL SECTION WITH SLOPE FLATTER THAN 2:1

For Swath and Ditch Contracts:

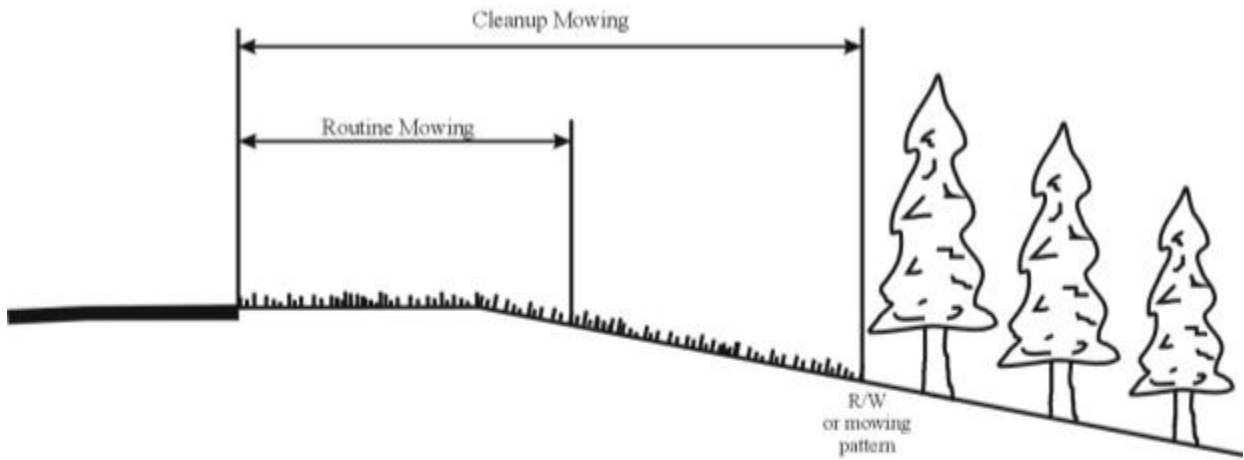

TYPICAL FILL SECTION WITH SLOPE FLATTER THAN 2:1.

Routine mow one swath beyond shoulder point.
Cleanup mow to R/W or mowing pattern.

TYPICAL FILL SECTION WITH SLOPE 2:1 AND STEEPER

For Swath and Ditch Contracts:

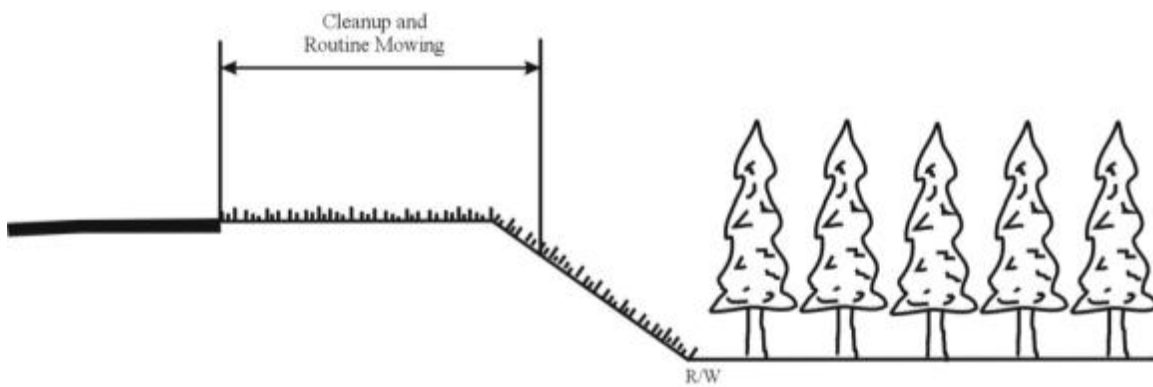

TYPICAL FILL SECTION WITH SLOPE 2:1 AND STEEPER.

Routine and cleanup mow shoulder and one swath beyond shoulder point.

TYPICAL FILL SECTION WITH ROOM BEHIND GUARDRAIL FOR MOWER

For Swath and Ditch Contracts:

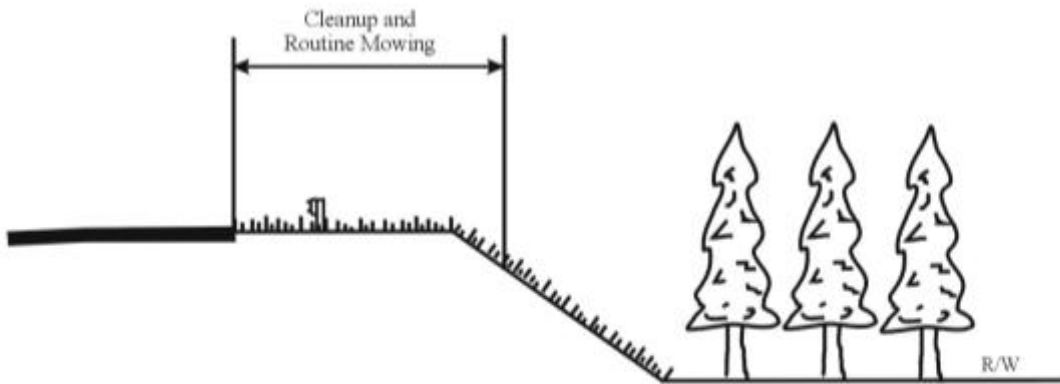

TYPICAL FILL SECTION WITH ROOM BEHIND GUARDRAIL FOR MOWER.

Routine and cleanup mow one swath behind guardrail and one swath down fill slope.

TYPICAL FILL SECTION WITH GUARDRAIL NEAR SHOULDER POINT

For Swath and Ditch Contracts:

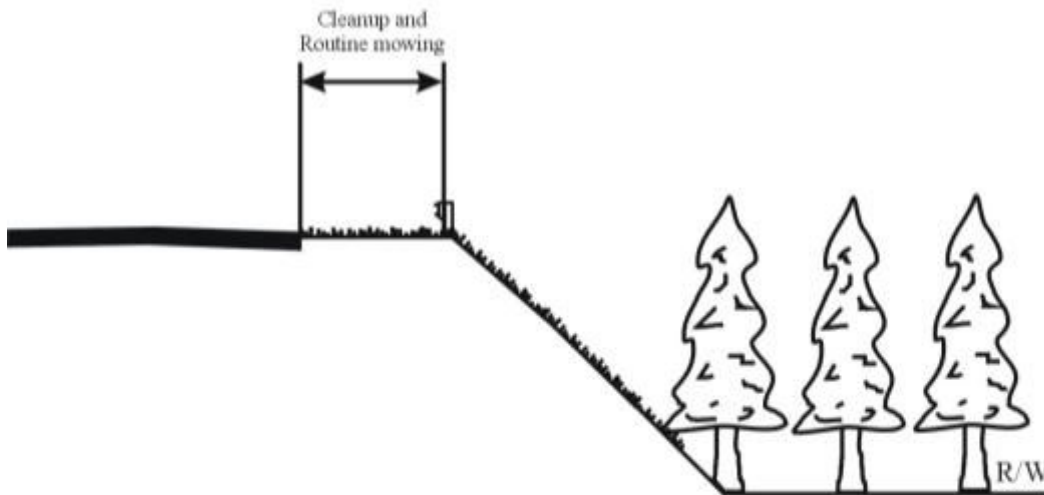

TYPICAL FILL SECTION WITH GUARDRAIL NEAR SHOULDER POINT.

Routine and cleanup mow to guardrail.

TYPICAL CURB AND GUTTER SECTION

For Swath and Ditch Contracts:



MULTI-LANE OPERATION DIAGRAMS

DIAGRAM 1

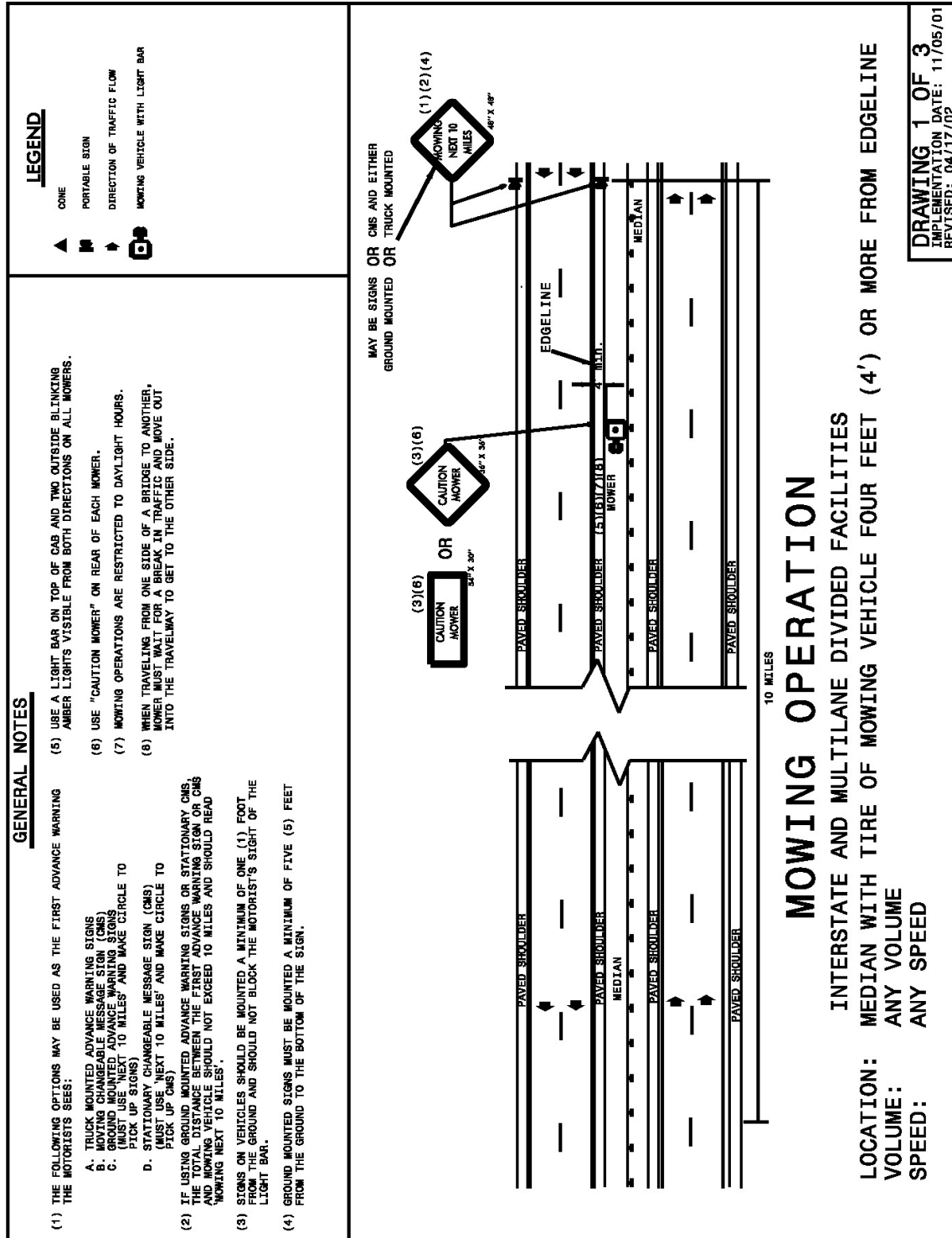
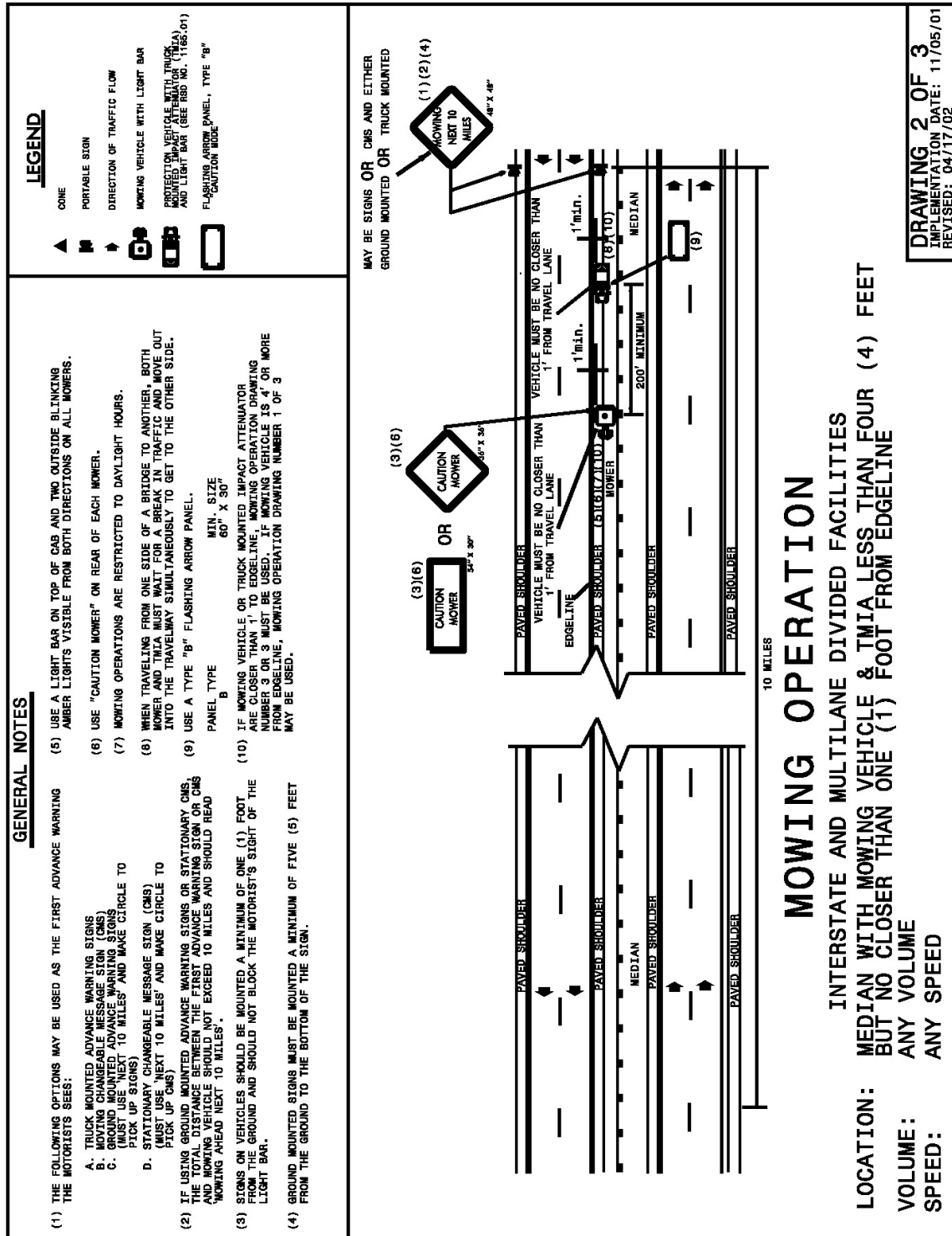
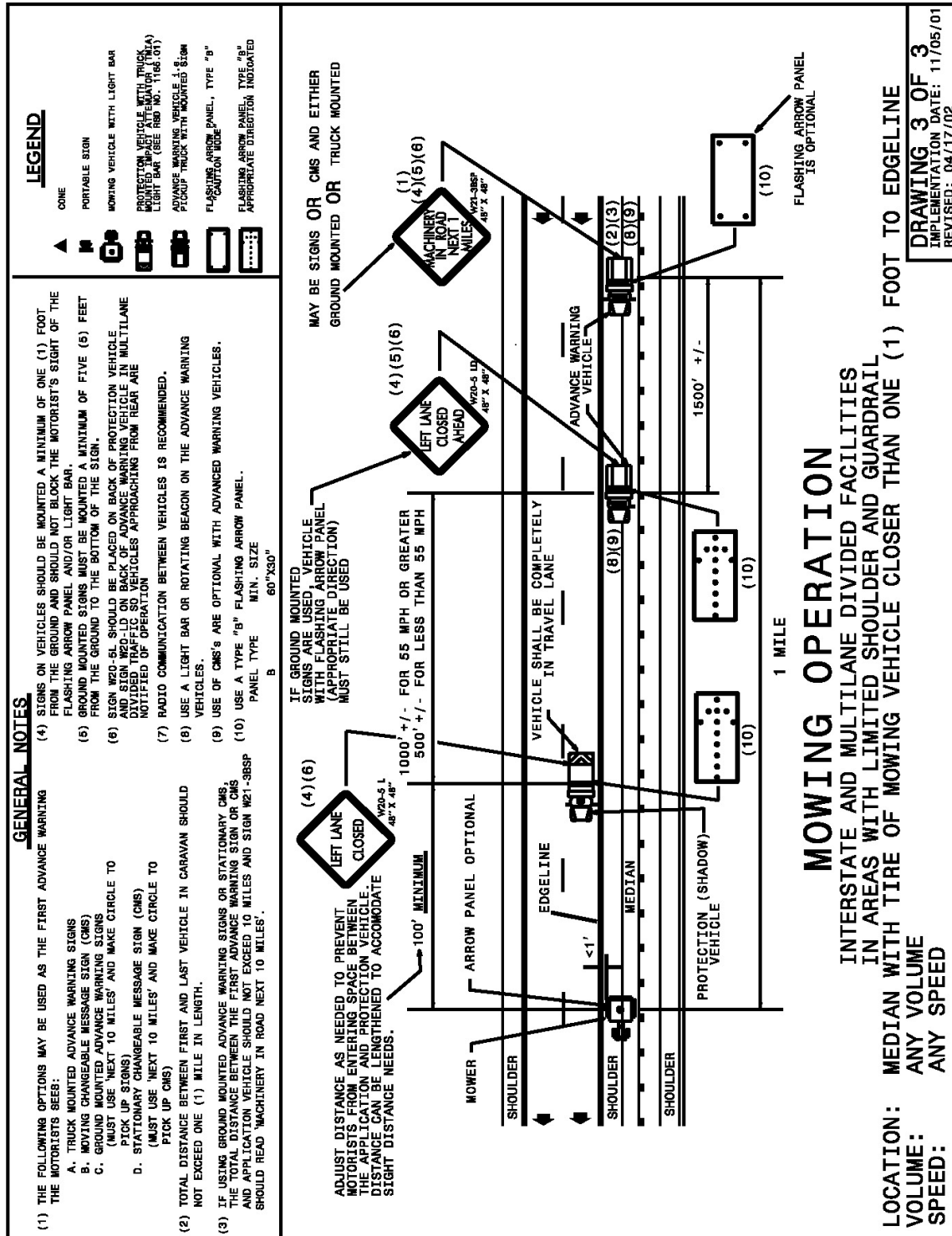

DIAGRAM 2



DRAWING 2 OF 3
 IMPLEMENTATION DATE: 11/05/01
 REVISED: 04/17/02

DIAGRAM 3



TYPICAL SECTIONS FOR TRIMMING AND LITTER PICKUP OPERATION

**TYPICAL INTERCHANGE CONFIGURATIONS
SHOWING THE LIMITS FOR
VEGETATION TRIMMING OF STATIONARY OBJECTS
AND LITTER/DEBRIS REMOVAL**

- Vegetation trimming includes sight distances at ramp connections
- Litter removal includes all areas visible from the road



LITTER PICKUP OPERATION DIAGRAMS

DIAGRAM 1

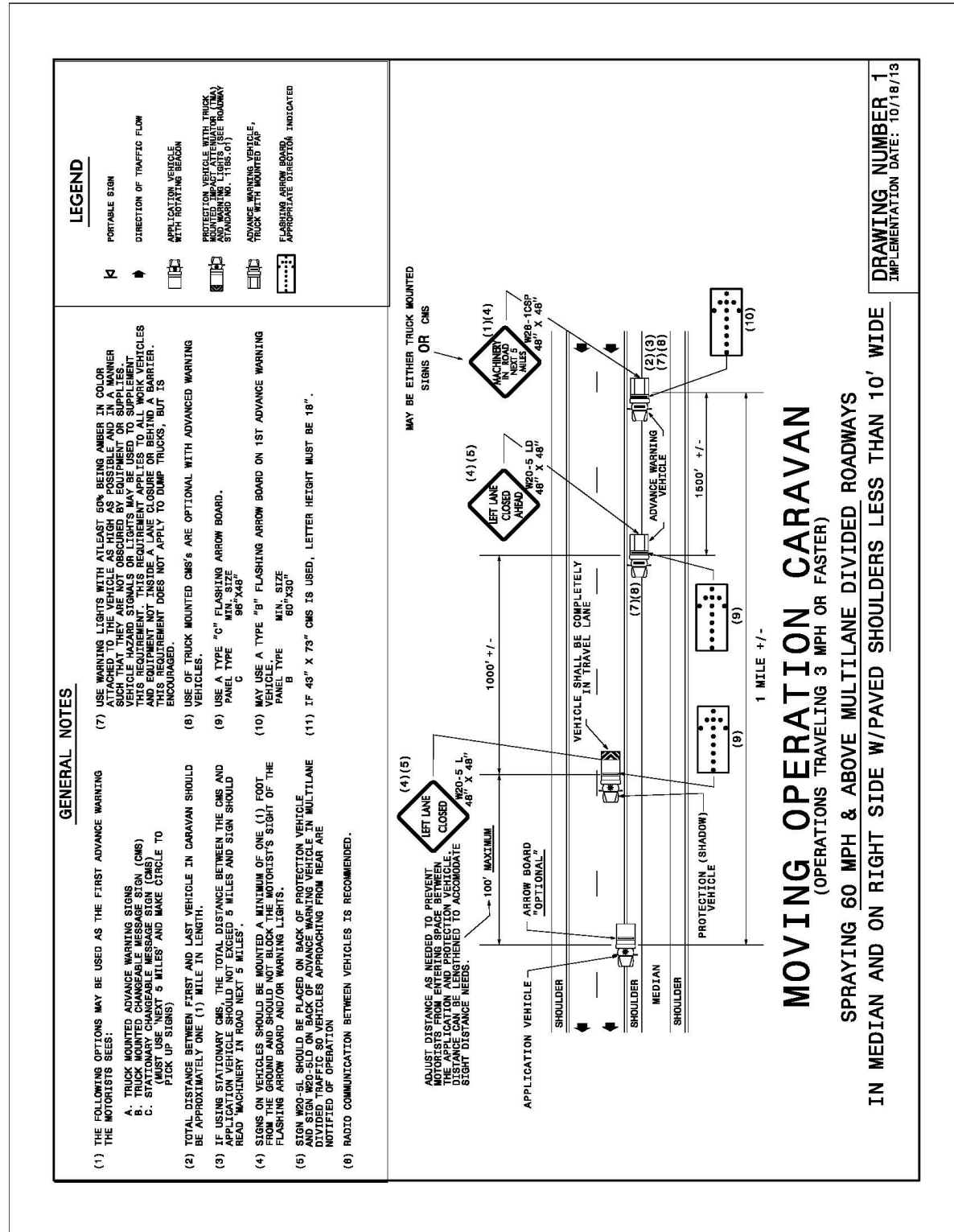

DIAGRAM 2

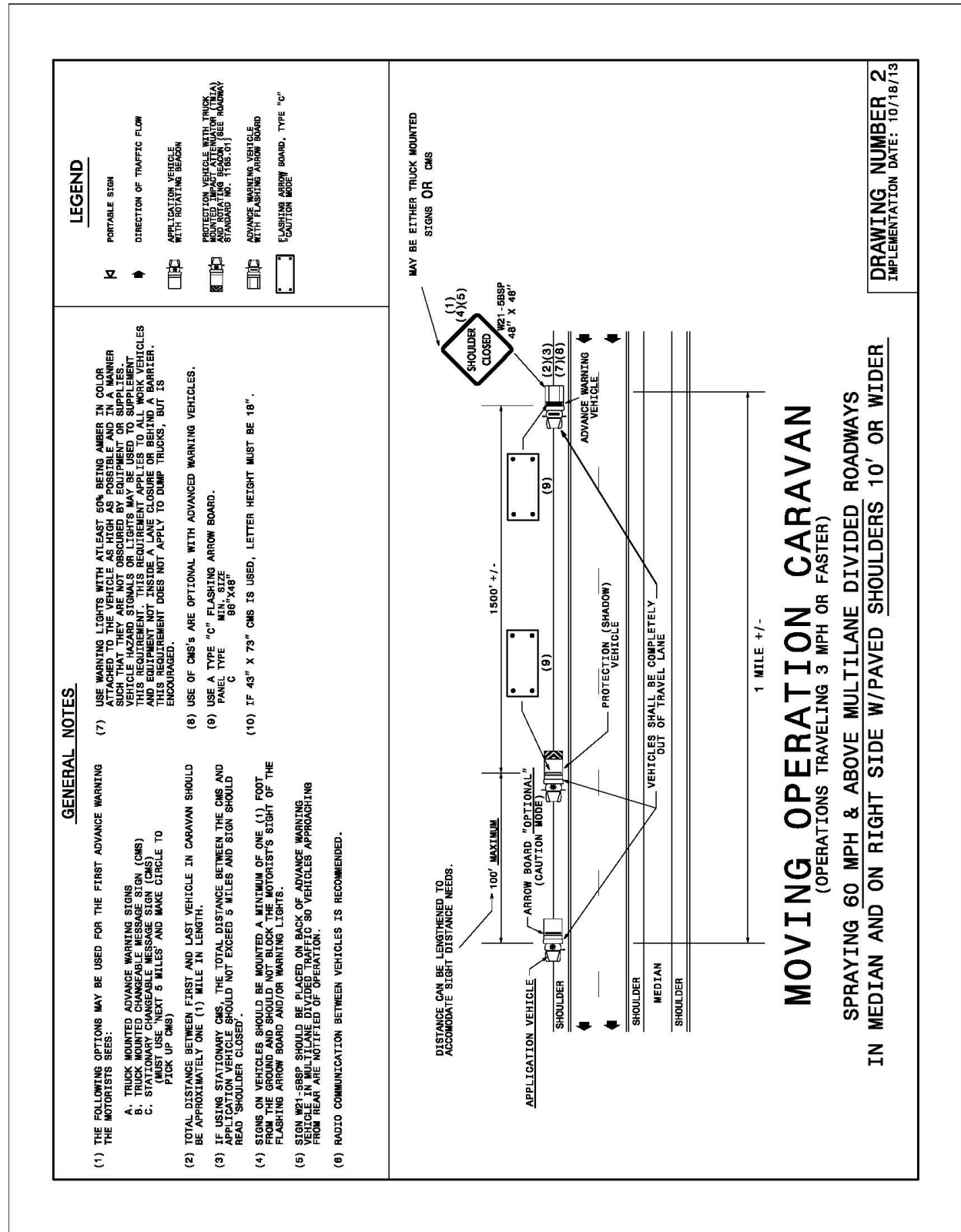

DIAGRAM 3

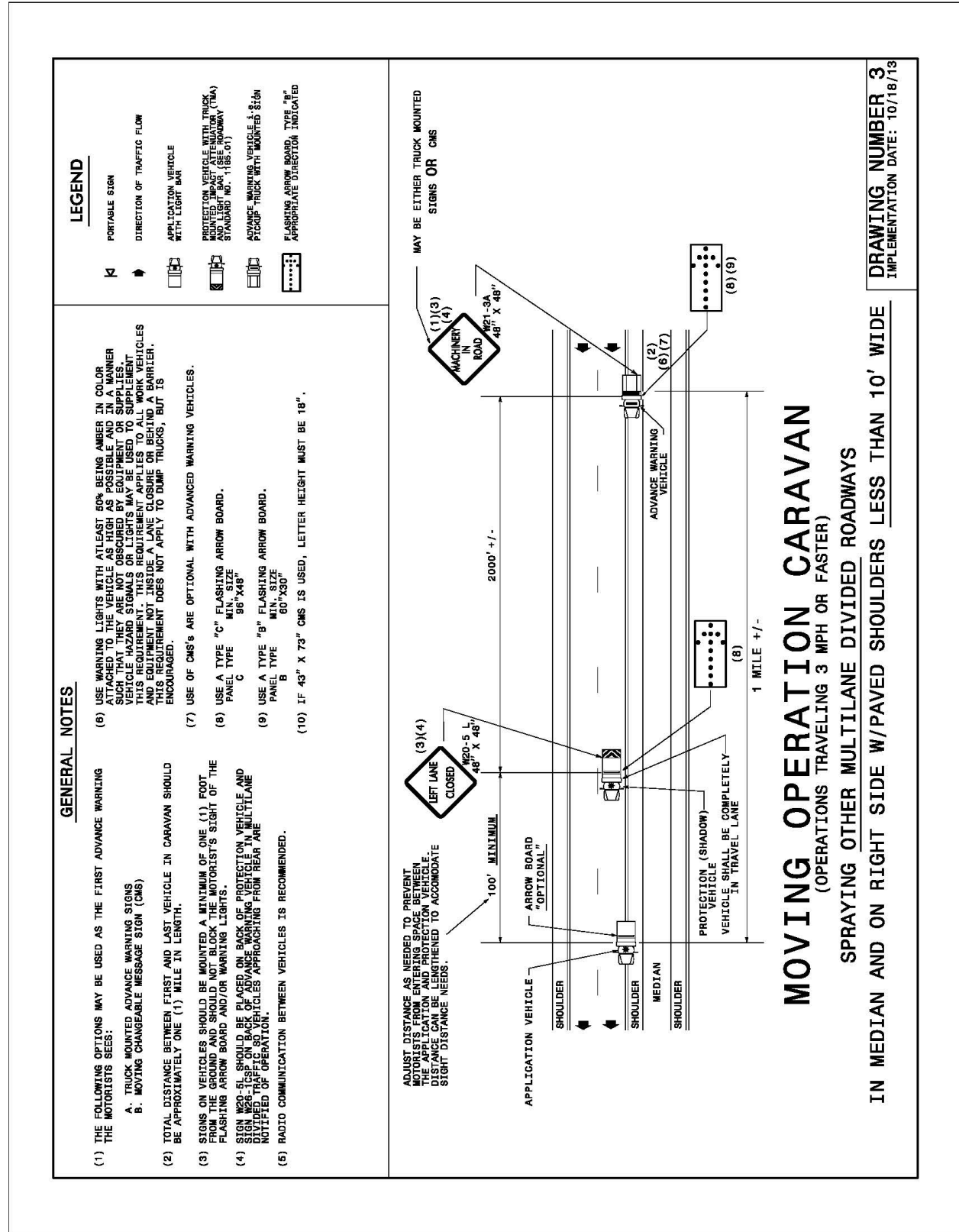

DIAGRAM 4

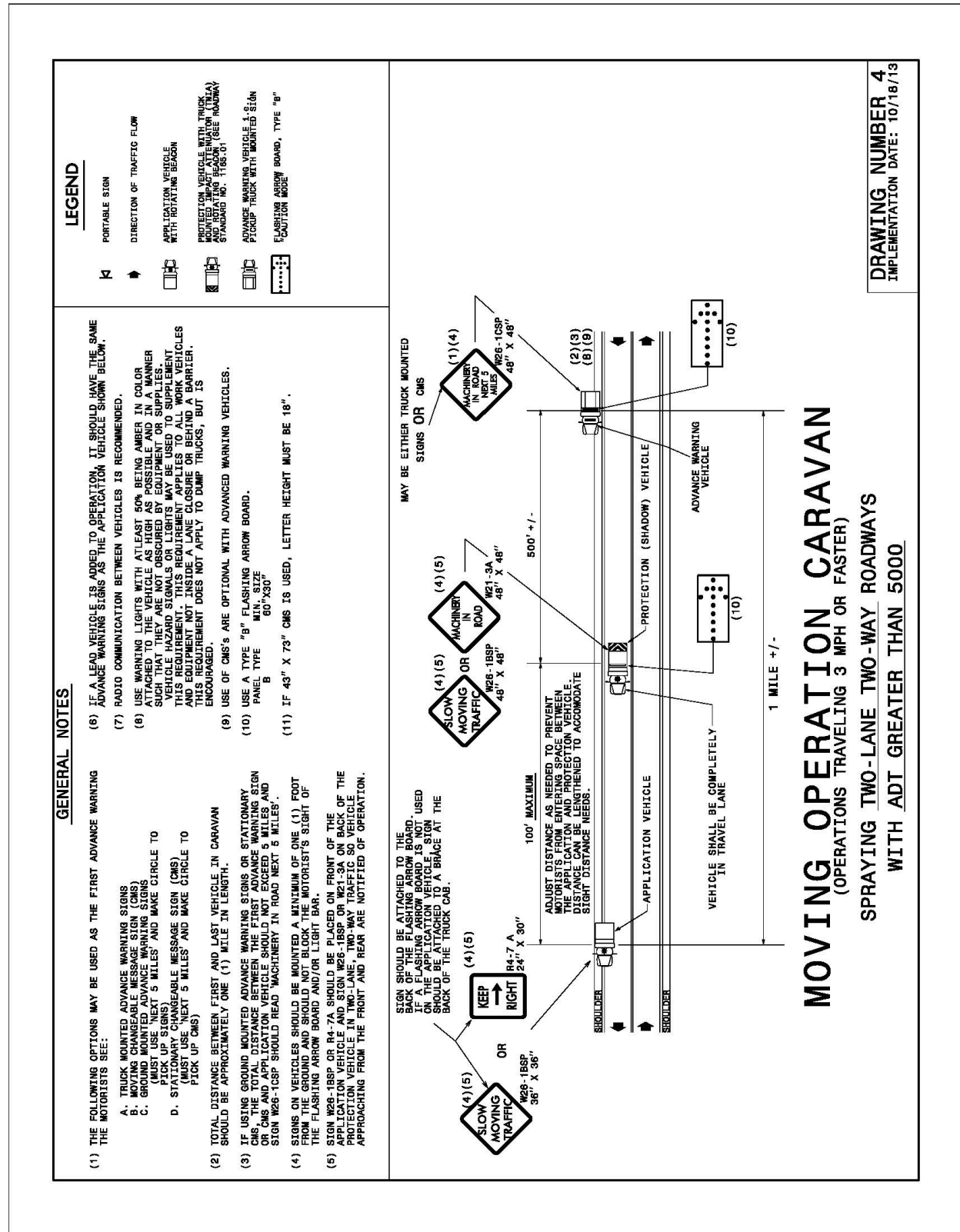
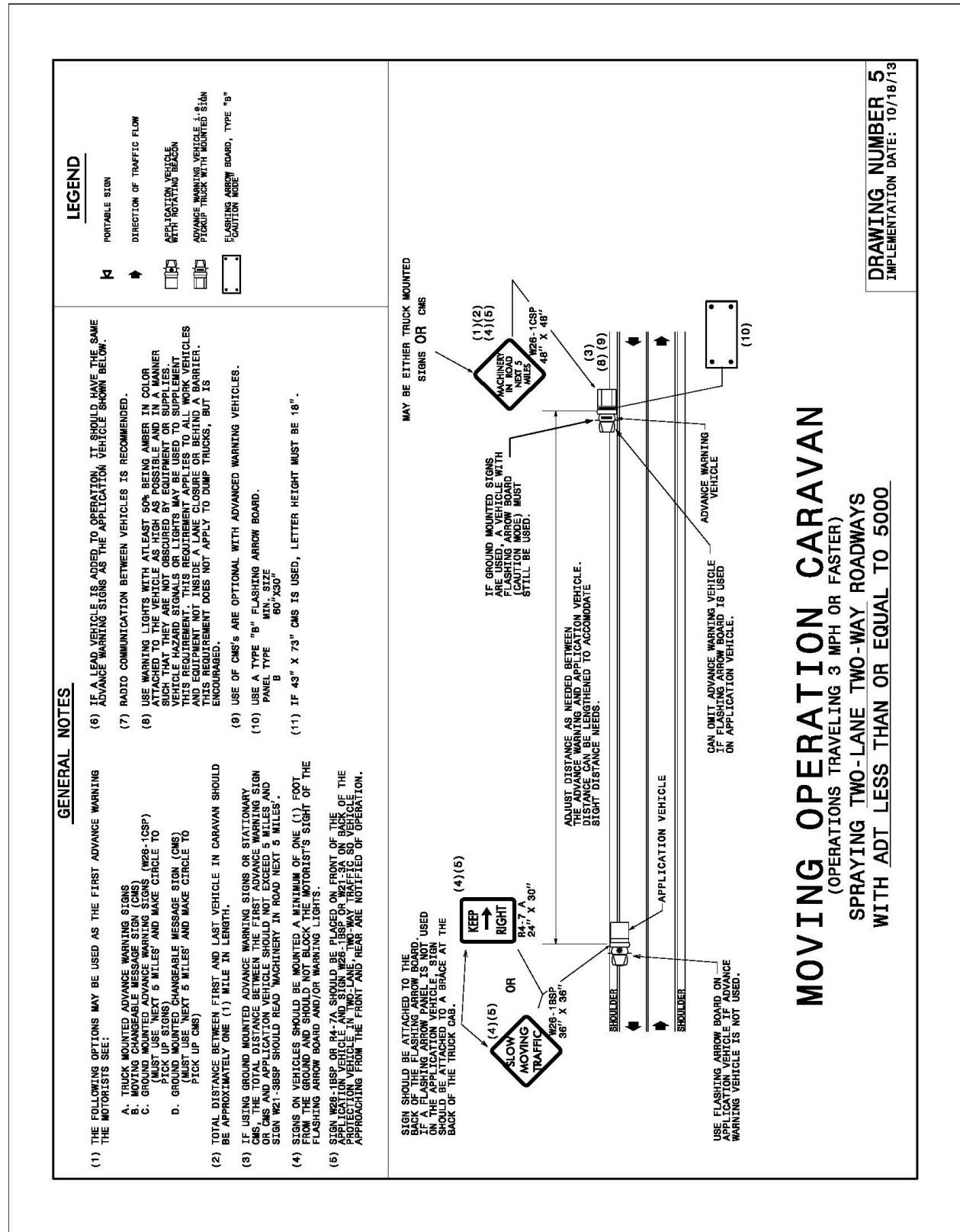
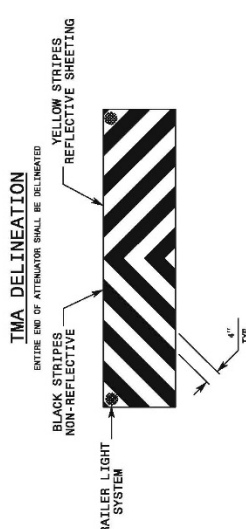
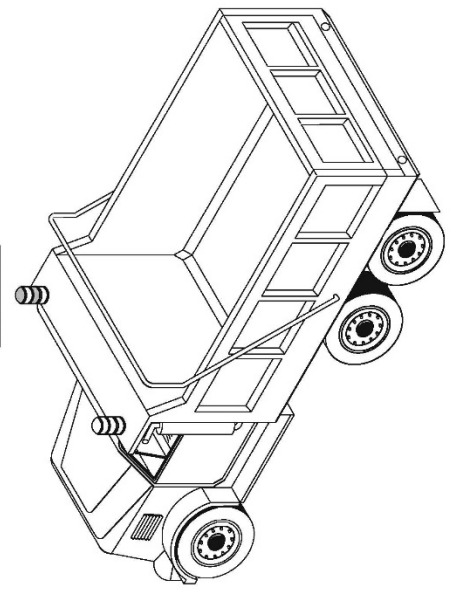
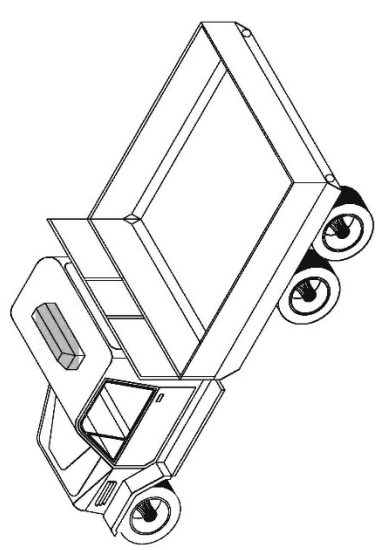

DIAGRAM 5



SERVICE VEHICLES

<p style="text-align: center;">STATE OF NORTH CAROLINA DEPT. OF TRANSPORTATION DIVISION OF HIGHWAYS RALEIGH, N.C.</p> <p style="text-align: right;">1-12</p>	<p style="text-align: center;">WORK VEHICLE LIGHTING SYSTEMS AND TMA DELINEATION</p> <p style="text-align: center;">ENGLISH STANDARD DRAWING FOR</p> <div style="display: flex; justify-content: space-around; align-items: center;"> <div style="width: 45%;"> <p style="text-align: center;">TMA DELINEATION</p>  <p style="text-align: center;">ENTIRE END OF ATTENUATOR SHALL BE DELINEATED</p> <p>BLACK STRIPES NON-REFLECTIVE</p> <p>YELLOW STRIPES REFLECTIVE SHEETING</p> <p>TRAILER LIGHT SYSTEM</p> <p style="text-align: right;">4" TYP.</p> </div> <div style="width: 45%;"> <p style="text-align: center;">DUMP BODY</p>  </div> <div style="width: 45%;"> <p style="text-align: center;">NON-DUMP BODY</p>  </div> </div> <p style="text-align: center;">STATE OF NORTH CAROLINA DEPT. OF TRANSPORTATION DIVISION OF HIGHWAYS RALEIGH, N.C.</p> <p style="text-align: right;">1-12</p>
<p style="text-align: center;">STATE OF NORTH CAROLINA DEPT. OF TRANSPORTATION DIVISION OF HIGHWAYS RALEIGH, N.C.</p> <p style="text-align: right;">1-12</p>	<p style="text-align: center;">WORK VEHICLE LIGHTING SYSTEMS AND TMA DELINEATION</p> <p style="text-align: center;">ENGLISH STANDARD DRAWING FOR</p> <p style="text-align: center;">GENERAL NOTES FOR TMA REQUIREMENTS</p> <ol style="list-style-type: none"> 1- WHEN TMA'S USED FOR SHADOW VEHICLES, CONTACT THE TMA MANUFACTURER FOR SPECIFIC TRUCK REQUIREMENTS. 2- TMA MUST MEET OR EXCEED THE REQUIREMENTS OF NCHRP 350 TEST LEVEL II FOR WORK ZONES WITH POSTED SPEED LIMIT OF 45 MPH OR LESS; OR TEST LEVEL III FOR WORK ZONES WITH POSTED SPEED LIMIT OF 50 MPH OR GREATER. TMA MAY EITHER BE TRUCK MOUNTED OR TRAILER MOUNTED. 3- SEE THE DEPARTMENT'S APPROVED PRODUCT LIST AT https://apps.dot.state.nc.us/vendor/approvedproducts. <p style="text-align: center;">STATE OF NORTH CAROLINA DEPT. OF TRANSPORTATION DIVISION OF HIGHWAYS RALEIGH, N.C.</p> <p style="text-align: right;">1-12</p>
<p style="text-align: center;">STATE OF NORTH CAROLINA DEPT. OF TRANSPORTATION DIVISION OF HIGHWAYS RALEIGH, N.C.</p> <p style="text-align: right;">1-12</p>	<p style="text-align: center;">WORK VEHICLE LIGHTING SYSTEMS AND TMA DELINEATION</p> <p style="text-align: center;">ENGLISH STANDARD DRAWING FOR</p> <p style="text-align: center;">GENERAL NOTES FOR TMA REQUIREMENTS</p> <ol style="list-style-type: none"> 1- WHEN TMA'S USED FOR SHADOW VEHICLES, CONTACT THE TMA MANUFACTURER FOR SPECIFIC TRUCK REQUIREMENTS. 2- TMA MUST MEET OR EXCEED THE REQUIREMENTS OF NCHRP 350 TEST LEVEL II FOR WORK ZONES WITH POSTED SPEED LIMIT OF 45 MPH OR LESS; OR TEST LEVEL III FOR WORK ZONES WITH POSTED SPEED LIMIT OF 50 MPH OR GREATER. TMA MAY EITHER BE TRUCK MOUNTED OR TRAILER MOUNTED. 3- SEE THE DEPARTMENT'S APPROVED PRODUCT LIST AT https://apps.dot.state.nc.us/vendor/approvedproducts. <p style="text-align: center;">STATE OF NORTH CAROLINA DEPT. OF TRANSPORTATION DIVISION OF HIGHWAYS RALEIGH, N.C.</p> <p style="text-align: right;">1-12</p>

SHEET 1 OF 1
1165.01

SHEET 1 OF 1
1165.01

SIGN DETAIL FOR LITTER/DEBRIS REMOVAL VEHICLE

**DETAIL OF SIGN TO BE MOUNTED
ON BACK OF ALL VEHICLES USED FOR
LITTER/DEBRIS REMOVAL**

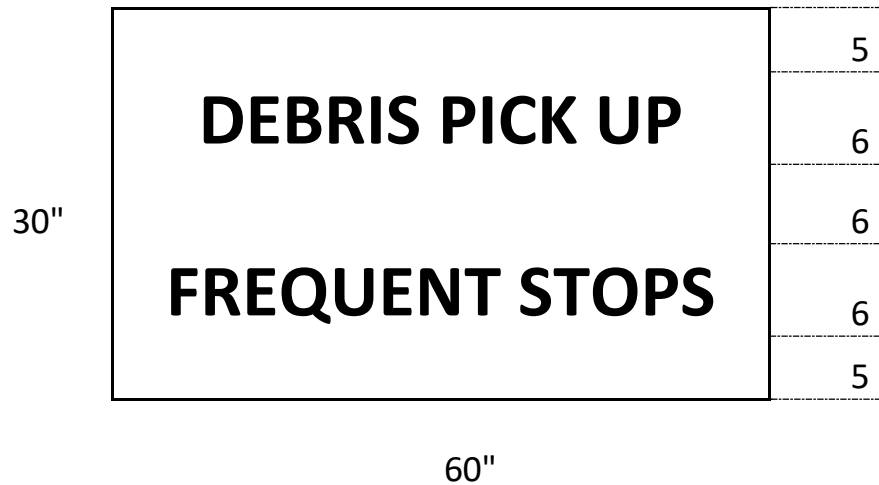

Lettering - Black

Background - Fluorescent Orange (Retroreflective)

REQUIRED SIGNS

Grass Mowing Advance Warning Signs (W10-10A and W10-10)

W10-10A
48" X 48"



W10-10
36"X36"
48"X48"

Caution Mower (W10-11A and W10-11)

W10-11A
36" x 36"



W10-11
54"X30"

Litter Pickup Advance Warning Signs (W10-10A and W10-10)

W10-10A
48" X 48"



W10-10
36"X36"
48"X48"

THREATENED AND ENDANGERED PLANT SPECIES SIGN

Information on each county can be found at this website:

<https://connect.ncdot.gov/resources/roadside/Pages/Field-Operations.aspx>

Current data and exact locations should be verified through Division and County personnel.

PLANT PROTECTION – NO MOWING/NO SPRAYING



SP-04315

24" X 24

PREPARATION AND SUBMISSION OF TRADITIONAL PAPER BIDS

As stated under “AWARD OF CONTRACT” above, the Engineer will evaluate the Bidder's proposal to determine the responsibility of the bid and insure compliance with contract. The Engineer, using his/her discretion, will determine whether a bidder is “responsible” and capable of performing the required work. The Bidder should demonstrate an understanding of the requirements of the contract, and that the requirements have been addressed in his/her bid to the satisfaction of the Engineer. The Bidder should demonstrate that he/she is capable of performing the required work under this contract, to the satisfaction of the Engineer.

PLEASE READ ALL INSTRUCTIONS CAREFULLY BEFORE PREPARING AND SUBMITTING YOUR BID

Paper bids shall be prepared and submitted in accordance with SSRS § 102-8 and the following requirements. Failure to comply with any requirement may cause the bid to be irregular and may be grounds for rejection of the bid. Only the Bid Submittal Package pages and all signed addenda shall be submitted as your proposal. **One (1) signed original and one (1) signed copy of the Bid Submittal Package and all signed addenda; shall be submitted as the Bidder’s proposal.**

1. The attached Bid Submittal Package (Bid Submittal Pages 1 of 17 through 17 of 17) furnished by the Department shall be used. The bid shall be submitted on the same proposal that has been furnished to the bidder by the Department. Copies of previous proposals shall be rejected.
2. All entries on the Contract Bid Form, including signatures shall be written in ink or typed.
3. The Bidder shall submit a unit price for each item listed in the Contract Bid Form. The Unit Price for the various contract items shall be written in figures. Unit prices shall be rounded off by the Bidder to contain **no more than TWO (2) decimal places.**
4. An Amount Bid shall be entered in the Contract Bid Form for each item that a Unit Price has been entered. The Amount Bid for each item shall be determined by multiplying each Unit Price by the quantity for that item, and shall be written in figures in the Amount Bid column in the Contract Bid Sheet.
5. The total bid shall be written in figures in the Total Bid for Project section in the Contract Bid Form. The Total Bid for Project shall be determined by adding the Amount Bid for each item.
6. Changes in any entry in the Bid Submittal Package shall be made by marking through the entry in ink and making the correct entry adjacent thereto in ink. A representative of the Bidder shall initial the change in ink. Do not use correction fluid, correction tape or similar product to make corrections.
7. The bid shall be properly executed on the included **Execution of Bid – Non-collusion Affidavit, Debarment Certification and Gift Ban Certification** form. All bids shall show the following information:
 - a. Name of corporation, partnership, limited liability company, joint venture, individual or firm, submitting bid. **Corporations that have a corporate seal should include it on the bid.**
 - b. Name of individual or representative submitting bid and position or title held on behalf of the bidder.
 - c. Name, signature, and position or title of witness.
8. The bid shall not contain any unauthorized additions, deletions, or conditional bids.
9. The Bidder shall not add any provision reserving the right to accept or reject an award, or to enter into a contract pursuant to an award.

10. The Bid Submittal Package shall be placed in a sealed envelope and shall be delivered to and received in the DOT Purchasing Section by **2:00 pm on December 2, 2024** at the address indicated in the table below:

MAILING ADDRESS FOR DELIVER OF BID VIA U.S. POSTAL SERVICE	OFFICE ADDRESS FOR DELIVERY BY ANY OTHER MEANS, SPECIAL DELIVERY, HAND DELIVERY, OVERNIGHT DELIVERY OR BY ANY OTHER CARRIER
BID NUMBER: 54-SH-05-PR12757 Attn: Steve Hussey North Carolina Department of Transportation Purchasing Section Address: 1510 Mail Service Center Raleigh, NC 27699-1510	BID NUMBER: 54-SH-05-PR12757 Attn: Steve Hussey North Carolina Department of Transportation Purchasing Section Address: 1 South Wilmington Street, Room 334B Raleigh, NC 27601

IMPORTANT NOTE: All paper bids shall be physically delivered to the office address listed above on or before the bid deadline in order to be considered timely, regardless of method of delivery (including U.S. mail). **This is an absolute requirement.** All risk of late arrival due to unanticipated delay – whether delivered by hand, U.S. Postal Service, courier or other delivery service is entirely on the Vendor. **It is the sole responsibility of the Vendor to have the bid physically in this Office by the specified time and date of opening.** The time of delivery will be marked on each bid when received, and any bid received after the bid submission deadline will be rejected. Sealed bids, subject to the conditions made a part hereof, will be received at the address indicated in the table in this Section, for furnishing and delivering the commodity or service as described herein.

Note that the U.S. Postal Service does not deliver mail to the specified office address but to the State’s Mail Service Center. Vendors are cautioned that bids sent via U.S. Mail, including Express Mail, may not be delivered by the Mail Service Center to the agency’s purchasing office on the due date in time to meet the bid deadline. All Vendors are urged to take the possibility of delay into account when submitting a bid.

All bids shall be submitted in a sealed envelope. Clearly mark each package with: (1) Vendor name; (2) the IFB number; and (3) the due date. Address the package(s) for delivery as shown in the table above.

Bids shall be marked on the outside of the sealed envelope with the Vendor’s name, IFB number, and date and time of opening. If Vendor is submitting more than one bid, each bid shall be submitted in a separate sealed envelope and marked accordingly. For delivery purposes, separate sealed bids from a single Vendor may be included in the same outer package. Do not include bids for more than one solicitation in the same package.

Failure to address proposals correctly could result in delayed delivery service.

OPENING OF BIDS

Bids subject to the conditions made a part hereof will be received until 2:00 pm on December 2, 2024 and then publicly opened for furnishing the services as described herein.

Opening of bids is to be in the NCDOT Transportation Building Complex located at 1 South Wilmington Street, Raleigh 27601

NOTE: Parking at the Transportation Building Complex is limited. Arrive early!

Issuance of this Proposal does not constitute a commitment on the part of the NCDOT to award or execute a Contract. The Department retains the right, in its sole discretion, at any time to reject any or all bids and to cancel or cancel and reissue a Proposal, before or after receipt and opening of bids in response thereto, or take any other actions it considers in its discretion to be in the best interest of the State.

BID SUBMITTAL PACKAGE

State Route Shoulder and Median Mowing
Including Vegetation Trimming and Litter/Debris Removal
NCDOT Highway Division 5
Vance County

DATE

November 4, 2024

PROPOSAL

54-SH-05-PR12757

CONTRACTING AGENCY

State of North Carolina
Department of Transportation
Raleigh, North Carolina

Bidder: _____

Company Name

CONTRACT BID FORM

ITEM	SEC	DESCRIPTION	QTY	UNIT	UNIT PRICE	AMOUNT BID
1	SP	Mowing – Interstate - Cleanup	300	SHM	\$	\$
2	SP	Mowing – Primary Divided – Cleanup	320	SHM	\$	\$
3	SP	Mowing – Primary Undivided – Cleanup	510	SHM	\$	\$
4	SP	Mowing – Secondary Paved – Cleanup	3,670	SHM	\$	\$
5	SP	Mowing – Secondary Unpaved – Cleanup	180	SHM	\$	\$
6	SP	Vegetation Removal at Stationary Objects	983,000	LF	\$	\$
7	SP	Vegetation Removal - Additional	6,684	SF	\$	\$
8	SP	Litter/Debris Removal	2,034	SHM	\$	\$
9	SP	Remobilization for Mowing	1	EA	\$	\$
TOTAL BID FOR PROJECT: \$						

THIS SECTION TO BE COMPLETED BY NORTH CAROLINA DEPARTMENT OF TRANSPORTATION

This bid has been reviewed in accordance with Article 103-1 of the Standard Specifications for Roads and Structures 2024.

Reviewed by _____ (date)

Accepted by NCDOT _____ (date)
Division Engineer

CONTRACTOR INFORMATION

Company Name: _____

Contractor License Number: _____

Address: _____

Phone(s): _____

Email: _____

Name of individual authorized to answer questions concerning the information contained herein:

Name: _____

Phone(s): _____

Email: _____

FEDERAL EMPLOYER IDENTIFICATION NUMBER

The Federal Employer Identification Number or alternate identification number (e.g., Social Security Number) is used for internal processing, including bid tabulation.

Pursuant to N.C.G.S. § 132-1.10(b) this identification number shall not be released to the public. This page is segregated for ease of redaction pursuant to a valid public records request.

Identification Number

This page will be removed and shredded, or otherwise kept confidential, before the procurement file is made available for public inspection.

REFERENCES

The Bidder shall provide three (3) references of government agencies and/or private firms for whom they have provided the services in this RFP on a contract basis during the last three (3) years:

Reference #1

Agency or Firm Name	
Business Address	
Mailing Address	
Contact Person	
Telephone	
Miles of Mowing Performed	

Reference #2

Agency or Firm Name	
Business Address	
Mailing Address	
Contact Person	
Telephone	
Miles of Mowing Performed	

Reference #3

Agency or Firm Name	
Business Address	
Mailing Address	
Contact Person	
Telephone	
Miles of Mowing Performed	

LIST OF MBE & WBE SUBCONTRACTORS

Firm Name and Address	Circle One	Item No.	Item Description	* Agreed upon Unit Price	** Dollar Volume of Item
Name Address	MBE WBE				
Name Address	MBE WBE				
Name Address	MBE WBE				
Name Address	MBE WBE				
Name Address	MBE WBE				
Name Address	MBE WBE				

* The Dollar Volume shown in this column shall be the Actual Price Agreed Upon by the Prime Contractor and the MBE/WBE subcontractor, and these prices will be used to determine the percentage of the MBE/WBE participation in the contract.

** Dollar Volume of MBE/WBE Subcontractor Percentage of Total Contract Bid Price:

**** Dollar Volume of MBE Subcontractor** \$ _____

MBE Percentage of Total Contract Bid Price _____%

**** Dollar Volume of WBE Subcontractor** \$ _____

WBE Percentage of Total Contract Bid Price _____%

If firm is a Material Supplier Only, show Dollar Volume as 60% of Agreed Upon Amount from Letter of Intent.

If firm is a Manufacturer, show Dollar Volume as 100% of Agreed Upon Amount from Letter of Intent.

LIST OF EQUIPMENT

LINE ITEM	QTY	DESCRIPTION	YEAR MODEL	OWN/ LEASE/ RENTAL OR SUBCONTRACT
1				
2				
3				
4				
5				
6				
7				
8				
9				
10				
11				
12				
13				
14				
15				

NOTE: CONTRACTOR MAY USE ADDITIONAL SHEETS AS NECESSARY

If the Contractor will not be self-performing the work, the Bidder shall present their lease/rental or subcontractor information with the bid response.

AWARD LIMITS ON MULTIPLE PROJECTS

It is the desire of the Proposer to be awarded contracts, the value of which will not exceed a total of \$ _____, for those projects indicated below on which bids are being opened on the same date as shown in the Proposal Form. Individual projects shall be indicated by placing the project number and county in the appropriate place below. Projects not selected will not be subject to an award limit.

(Project Number)

(County)

(Project Number)

(County)

(Project Number)

(County)

(Project Number)

(County)

*If a Proposer desires to limit the total amount of work awarded to him in this letting, he shall state such limit in the space provided above in the second line of this form.

It is agreed that in the event that I am (we are) the successful bidder on indicated projects, the total value of which is more than the above stipulated award limits, the Board of Transportation will award me (us) projects from among those indicated which have a total value not exceeding the award limit and which will result in the best advantage to the Department of Transportation.

**Signature of Authorized Person

**Only those persons authorized to sign bids under the provisions of Subarticle 102-8(A)(8) shall be authorized to sign this form.

**NON-COLLUSION, DEBARMENT AND GIFT BAN CERTIFICATION
CORPORATION**

The prequalified bidder, declares (or certifies, verifies, or states) under penalty of perjury under the laws of the United States that neither he, nor any official, agent or employee has entered into any agreement, participated in any collusion, or otherwise taken any action which is in restraint of free competitive bidding in connection with any bid or contract, that the prequalified bidder has not been convicted of violating *N.C.G.S. §133-24* within the last three years, and that the prequalified bidder intends to do the work with his own bona fide employees or subcontractors and will not bid for the benefit of another contractor.

By submitting this non-collusion, debarment and gift ban certification, the Contractor is attesting his status under penalty of perjury under the laws of the United States in accordance with the Debarment Certification attached, provided that the Debarment Certification also includes any required statements concerning exceptions that are applicable.

N.C.G.S. §133-32 and Executive Order 24 prohibit the offer to, or acceptance by, any State Employee of any gift from anyone with a contract with the State, or from any person seeking to do business with the State. By execution of any response in this procurement, you attest, for your entire organization and its employees or agents, that you are not aware that any such gift has been offered, accepted, or promised by any employees of your organization.

SIGNATURE OF PREQUALIFIED BIDDER

Full name of Corporation

Address as Prequalified

Attest _____ By _____
Secretary/Assistant Secretary President/Vice President/Assistant Vice President
(Select appropriate title) (Select appropriate title)

Print or Type Signer's name Print or Type Signer's name



**NON-COLLUSION, DEBARMENT AND GIFT BAN CERTIFICATION
PARTNERSHIP**

The prequalified bidder, declares (or certifies, verifies, or states) under penalty of perjury under the laws of the United States that neither he, nor any official, agent or employee has entered into any agreement, participated in any collusion, or otherwise taken any action which is in restraint of free competitive bidding in connection with any bid or contract, that the prequalified bidder has not been convicted of violating *N.C.G.S. § 133-24* within the last three years, and that the prequalified bidder intends to do the work with its own bona fide employees or subcontractors and will not bid for the benefit of another contractor.

By submitting this non-collusion, debarment and gift ban certification, the Contractor is attesting his status under penalty of perjury under the laws of the United States in accordance with the Debarment Certification attached, provided that the Debarment Certification also includes any required statements concerning exceptions that are applicable.

N.C.G.S. § 133-32 and Executive Order 24 prohibit the offer to, or acceptance by, any State Employee of any gift from anyone with a contract with the State, or from any person seeking to do business with the State. By execution of any response in this procurement, you attest, for your entire organization and its employees or agents, that you are not aware that any such gift has been offered, accepted, or promised by any employees of your organization.

SIGNATURE OF PREQUALIFIED BIDDER

Full Name of Partnership

Address as Prequalified

Signature of Witness

Signature of Partner

Print or Type Signer's Name

Print or Type Signer's Name

**NON-COLLUSION, DEBARMENT AND GIFT BAN CERTIFICATION
LIMITED LIABILITY COMPANY**

The prequalified bidder, declares (or certifies, verifies, or states) under penalty of perjury under the laws of the United States that neither he, nor any official, agent or employee has entered into any agreement, participated in any collusion, or otherwise taken any action which is in restraint of free competitive bidding in connection with any bid or contract, that the prequalified bidder has not been convicted of violating *N.C.G.S. § 133-24* within the last three years, and that the prequalified bidder intends to do the work with its own bona fide employees or subcontractors and will not bid for the benefit of another contractor.

By submitting this non-collusion, debarment and gift ban certification, the Contractor is attesting his status under penalty of perjury under the laws of the United States in accordance with the Debarment Certification attached, provided that the Debarment Certification also includes any required statements concerning exceptions that are applicable.

N.C.G.S. § 133-32 and Executive Order 24 prohibit the offer to, or acceptance by, any State Employee of any gift from anyone with a contract with the State, or from any person seeking to do business with the State. By execution of any response in this procurement, you attest, for your entire organization and its employees or agents, that you are not aware that any such gift has been offered, accepted, or promised by any employees of your organization.

SIGNATURE OF PREQUALIFIED BIDDER

Full Name of Firm

Address as Prequalified

Signature of Witness

Signature of Member/Manager/Authorized Agent
(Select appropriate Title)

Print or Type Signer's Name

Print or Type Signer's Name

NON-COLLUSION, DEBARMENT AND GIFT BAN CERTIFICATION

JOINT VENTURE (2) or (3)

The prequalified bidder, declares (or certifies, verifies, or states) under penalty of perjury under the laws of the United States that neither he, nor any official, agent or employee has entered into any agreement, participated in any collusion, or otherwise taken any action which is in restraint of free competitive bidding in connection with any bid or contract, that the prequalified bidder has not been convicted of violating *N.C.G.S. § 133-24* within the last three years, and that the prequalified bidder intends to do the work with its own bona fide employees or subcontractors and will not bid for the benefit of another contractor.

By submitting this non-collusion, debarment and gift ban certification, the Contractor is attesting his status under penalty of perjury under the laws of the United States in accordance with the Debarment Certification attached, provided that the Debarment Certification also includes any required statements concerning exceptions that are applicable.

N.C.G.S. § 133-32 and Executive Order 24 prohibit the offer to, or acceptance by, any State Employee of any gift from anyone with a contract with the State, or from any person seeking to do business with the State. By execution of any response in this procurement, you attest, for your entire organization and its employees or agents, that you are not aware that any such gift has been offered, accepted, or promised by any employees of your organization.

SIGNATURE OF PREQUALIFIED BIDDER

Instructions: **2 Joint Venturers** Fill in lines (1), (2) and (3) and execute. **3 Joint Venturers** Fill in lines (1), (2), (3) and (4) and execute. On Line (1), fill in the name of the Joint Venture Company. On Line (2), fill in the name of one of the joint venturers and execute below in the appropriate manner. On Line (3), print or type the name of the other joint venturer and execute below in the appropriate manner. On Line (4), fill in the name of the third joint venturer, if applicable and execute below in the appropriate manner.

(1) _____
Name of Joint Venture

(2) _____
Name of Contractor

Address as Prequalified

Signature of Witness or Attest

BY

Signature of Contractor

Print or Type Signer's Name

AND

Print or Type Signer's Name

(3) _____
Name of Contractor

Address as Prequalified

Signature of Witness or Attest

BY

Signature of Contractor

Print or Type Signer's Name

AND

Print or Type Signer's Name

(4) _____
Name of Contractor

Address as Prequalified

Signature of Witness or Attest

BY

Signature of Contractor

Print or Type Signer's Name

AND

Print or Type Signer's Name

**NON-COLLUSION, DEBARMENT AND GIFT BAN CERTIFICATION
INDIVIDUAL DOING BUSINESS UNDER A FIRM NAME**

The prequalified bidder, declares (or certifies, verifies, or states) under penalty of perjury under the laws of the United States that neither he, nor any official, agent or employee has entered into any agreement, participated in any collusion, or otherwise taken any action which is in restraint of free competitive bidding in connection with any bid or contract, that the prequalified bidder has not been convicted of violating *N.C.G.S. § 133-24* within the last three years, and that the prequalified bidder intends to do the work with its own bona fide employees or subcontractors and will not bid for the benefit of another contractor.

By submitting this non-collusion, debarment and gift ban certification, the Contractor is attesting his status under penalty of perjury under the laws of the United States in accordance with the Debarment Certification attached, provided that the Debarment Certification also includes any required statements concerning exceptions that are applicable.

N.C.G.S. § 133-32 and Executive Order 24 prohibit the offer to, or acceptance by, any State Employee of any gift from anyone with a contract with the State, or from any person seeking to do business with the State. By execution of any response in this procurement, you attest, for your entire organization and its employees or agents, that you are not aware that any such gift has been offered, accepted, or promised by any employees of your organization.

SIGNATURE OF PREQUALIFIED BIDDER

Name of Prequalified Bidder

Individual Name

Trading and Doing Business As

Full name of Firm

Address as Prequalified

Signature of Witness

Signature of Prequalified Bidder, Individual

Print or Type Signer's Name

Print or Type Signer's Name

**NON-COLLUSION, DEBARMENT AND GIFT BAN CERTIFICATION
INDIVIDUAL DOING BUSINESS IN HIS OWN NAME**

The prequalified bidder, declares (or certifies, verifies, or states) under penalty of perjury under the laws of the United States that neither he, nor any official, agent or employee has entered into any agreement, participated in any collusion, or otherwise taken any action which is in restraint of free competitive bidding in connection with any bid or contract, that the prequalified bidder has not been convicted of violating *N.C.G.S. § 133-24* within the last three years, and that the prequalified bidder intends to do the work with its own bona fide employees or subcontractors and will not bid for the benefit of another contractor.

By submitting this non-collusion, debarment and gift ban certification, the Contractor is attesting his status under penalty of perjury under the laws of the United States in accordance with the Debarment Certification attached, provided that the Debarment Certification also includes any required statements concerning exceptions that are applicable.

N.C.G.S. § 133-32 and Executive Order 24 prohibit the offer to, or acceptance by, any State Employee of any gift from anyone with a contract with the State, or from any person seeking to do business with the State. By execution of any response in this procurement, you attest, for your entire organization and its employees or agents, that you are not aware that any such gift has been offered, accepted, or promised by any employees of your organization.

SIGNATURE OF PREQUALIFIED BIDDER

Name of Prequalified Bidder

Print or Type Name

Address as Prequalified

Signature of Prequalified Bidder, Individually

Print or Type Signer's Name

Signature of Witness

Print or Type Signer's name

DEBARMENT CERTIFICATION

Conditions for certification:

1. The prequalified bidder shall provide immediate written notice to the Department if at any time the bidder learns that his certification was erroneous when he submitted his debarment certification or explanation filed with the Department, or has become erroneous because of changed circumstances.
2. The terms *covered transaction, debarred, suspended, ineligible, lower tier covered transaction, participant, person, primary covered transaction, principal, proposal, and voluntarily excluded*, as used in this provision, have the meanings set out in the Definitions and Coverage sections of the rules implementing Executive Order 12549. A copy of the Federal Rules requiring this certification and detailing the definitions and coverages may be obtained from the Contract Officer of the Department.
3. The prequalified bidder agrees by submitting this form, that he will not knowingly enter into any lower tier covered transaction with a person who is debarred, suspended, declared ineligible, or voluntarily excluded from participation in NCDOT contracts, unless authorized by the Department.
4. For Federal Aid projects, the prequalified bidder further agrees that by submitting this form he will include the Federal-Aid Provision titled *Required Contract Provisions Federal-Aid Construction Contract (Form FHWA PR 1273)* provided by the Department, without subsequent modification, in all lower tier covered transactions.
5. The prequalified bidder may rely upon a certification of a participant in a lower tier covered transaction that he is not debarred, suspended, ineligible, or voluntarily excluded from the covered transaction, unless he knows that the certification is erroneous. The bidder may decide the method and frequency by which he will determine the eligibility of his subcontractors.
6. Nothing contained in the foregoing shall be construed to require establishment of a system of records in order to render in good faith the certification required by this provision. The knowledge and information of a participant is not required to exceed that which is normally possessed by a prudent person in the ordinary course of business dealings.
7. Except as authorized in paragraph 6 herein, the Department may terminate any contract if the bidder knowingly enters into a lower tier covered transaction with a person who is suspended, debarred, ineligible, or voluntarily excluded from participation in this transaction, in addition to other remedies available by the Federal Government.

DEBARMENT CERTIFICATION

The prequalified bidder certifies to the best of his knowledge and belief, that he and his principals:

- a. Are not presently debarred, suspended, proposed for debarment, declared ineligible, or voluntarily excluded from covered transactions by any Federal department or agency;
- b. Have not within a three-year period preceding this proposal been convicted of or had a civil judgment rendered against them for commission of fraud or a criminal offense in connection with obtaining, attempting to obtain, or performing a public (Federal, State or local) transaction or contract under a public transaction; violation of Federal or State antitrust statutes or commission of embezzlement, theft, forgery, bribery, falsification or destruction of records; making false statements; or receiving stolen property;
- c. Are not presently indicted for or otherwise criminally or civilly charged by a governmental entity (Federal, State or local) with commission of any of the offenses enumerated in paragraph b. of this certification; and
- d. Have not within a three-year period preceding this proposal had one or more public transactions (Federal, State or local) terminated for cause or default.
- e. Will submit a revised Debarment Certification immediately if his status changes and will show in his bid proposal an explanation for the change in status.

If the prequalified bidder cannot certify that he is not debarred, he shall provide an explanation with this submittal. An explanation will not necessarily result in denial of participation in a contract.

Failure to submit a non-collusion and debarment certification will result in the prequalified bidder's bid being considered non-responsive.

Check here if an explanation is attached to this certification.

CHECKLIST FOR BIDDER

This checklist has been provided for your benefit to assist you in completing your Bid Submittal Package to help ensure that all necessary items have been completed.

- Bid Proposal Package
- Identification Number
- Three References
- List of MB & WB Subcontractors
- List of equipment that your firm owns/leases/rents/subcontracts
- Award Limits on Multiple Projects
- Execution of Proposal
- Non-Collusion Affidavit and Debarment Certification appropriate for your business
- Addendum(s), if applicable
- Bid Submittal Package including one (1) signed original and one (1) signed copy

**YOU MUST BE PRE-QUALIFIED TO BID AS A BIDDER OR POC PRIME CONTRACTOR!
SEE PROJECT SPECIAL PROVISIONS FOR FURTHER INSTRUCTION.**

End of bid submittal package!